

CONCESSIONS

TENANT
DESIGN
MANUAL

DFW DFW



100% Final March 07, 2003
UPDATED September 24, 2019

TERMINALS A, B & E

TABLE OF CONTENTS

1.0	INTRODUCTION.....	1
1.1	Introduction.....	1
1.2	Definitions.....	2
1.3	Design Reference Outline	6
1.4	Codes and Standards.....	8
2.0	EXISTING BUILDING CONDITIONS.....	9
2.1	Terminals A, B, C & E.....	9
2.1.1	Ramp Level.....	9
2.1.2	Concourse Level.....	9
2.2	Design Conditions.....	10
2.2.1	Design Condition A – In-line	13
2.2.1.1	Design Condition A1 – In-Line, Single Bay with Neutral Frame.....	14
2.2.1.2	Design Condition A2 – In-Line, Default (or Optional)	18
2.2.1.3	Design Condition A3 – In-Line, Partial Bay with Neutral Frame	26
2.2.1.4	Design Condition A4, Single Bay Neutral Frame	30
2.2.1.5	Design Condition A5 – In-Line, Wedge 9’-0” Neutral Frame	32
2.2.1.6	Design Condition A6 – In-Line, Split-Condition Neutral Frame	35
2.2.2	Design Condition B – Freestanding	39
2.2.2.1	Design Condition B1 – Freestanding, Omni-Bay with Neutral Frame	40
2.2.2.2	Design Condition B2 – Freestanding, Omni-Bay, Shared Seating Area and Common Railing.....	44
2.2.2.3	Design Condition B3 – Freestanding, with No Neutral Frame,	46
2.2.2.4	Design Condition B4 – Freestanding, No Neutral Frame.....	47
2.2.2.5	Design Condition B5 – Freestanding, with No Neutral Frame, Facing the B Stinger Concourse	48
2.2.3	Design Condition C – Corner	49
2.2.3.1	Design Condition C1 – Corner Condition with Neutral Frames.....	50
2.2.3.2	Design Condition C2 – Corner with 8’-2” and 11’-6” Neutral Frames	56
2.2.3.3	Design Condition C3 – Corner with 9’ Neutral Frame on Both Sides.....	61

TABLE OF CONTENTS

3.0	DESIGN CRITERIA.....	64
3.1	Lease Space Guidelines	64
3.1.1	Storefront	64
3.1.1.1	Neutral Frame	64
3.1.1.2	Storefront Materials	66
3.1.1.3	Openness/Transparency	66
3.1.1.4	Store Entrances	66
3.1.2	Merchandise Displays	68
3.1.3	Flooring Materials and Transition	69
3.1.4	Ceilings.....	71
3.1.5	Interior Walls and Doors	72
3.1.6	Demising Walls	72
3.1.7	Security.....	73
3.2	Shoe Shine Tenants.....	73
3.3	Food and Beverage Tenants	73
3.3.1	Design Guidelines	73
3.3.2	Take-Away Counters.....	74
3.3.3	Grab & Go Units.....	75
3.3.4	Display	76
3.3.5	Equipment	77
3.3.6	Lighting.....	77
3.3.7	Storage.....	77
3.3.8	Allowance for Grease Storage.....	77
3.4	Railings	78
3.4.1	Railing Construction Criteria	79
3.5	Signage Criteria	81
3.5.1	General Requirements.....	81
3.5.2	Sign Materials and Construction	82
3.5.2.1	Illuminated Signs	83
3.5.2.2	Non-Illuminated Signs.....	83
3.5.3	Primary Sign Types	83

TABLE OF CONTENTS

3.5.3.1	Blade Signage.....	84
3.5.3.2	Feature Wall Signage.....	85
3.5.3.3	Vertical/Jamb Signage	86
3.5.3.4	Wall Signage	87
3.5.3.5	Railing Signage	88
3.5.3.6	Railing signage criteria	89
3.5.3.7	Railing Signage Configuration.....	91
3.5.3.8	Bulkhead Signage	94
3.5.4	Specialty Signage.....	95
3.5.5	Menu Boards	95
3.6	Lighting Criteria.....	95
3.6.1	Lighting Technology.....	95
3.6.1.1	Lighting within the Identity Control Zone.....	96
3.6.2	General Tenant Lighting Standards.....	97
3.7	Acoustics and Public Address	98
3.7.1	Acoustics.....	98
3.7.2	Sound Transmission Class (STC) Planning Matrix.....	99
3.7.3	Public Address System	100
3.8	Mechanical, Electrical and Plumbing Requirements.....	100
3.8.1	Heating, Ventilation, and Air Conditioning.....	101
3.8.1.1	Concession Spaces Control Requirements.....	103
3.8.1.2	Vent Hood Requirements	104
3.8.2	Electrical	105
3.8.3	Plumbing	106
3.8.4	Natural Gas/Liquid Propane Gas.....	107
3.9	Fire Protection and Life Safety	107
3.9.1	Smoke Control.....	108
3.9.2	Automatic Smoke Control Systems.....	108
3.9.3	Automatic Sprinklers.....	109
3.9.4	Strobes and Speakers	109
3.9.5	Emergency Lighting	110
3.9.6	Means of Egress	110

TABLE OF CONTENTS

3.9.7	Interior Finishes.....	110
3.10	Telephone / Data	110
3.11	Roof Penetrations	111
3.12	Structural Loads	111
4.0	RESPONSIBILITIES AND PROCEDURES.....	112
4.1	Codes and Standards.....	112
4.1.1	Professional Responsibility Statement	112
4.1.2	Applicable Building Codes	112
4.1.3	Health Department License and Permit.....	112
4.1.4	Sustainability	113
4.1.5	Accessibility Standards	113
4.1.6	DFW Design Criteria Manual	114
5.0	DESIGN REVIEW AND CODE SUBMITTAL.....	115
5.1.1	Schematic Design Submittal – 35% Review	116
5.1.2	Contract Documents Submittal – 95% Review	116
5.1.3	Permit Documents Submittal.....	118
5.1.4	Code Review Process	119
5.2	Tenant Lease Space Return Policy.....	119
5.3	Maintenance of Building Systems	119
6.0	CONSTRUCTION	120
6.1	Procedures	120
6.1.1	Temporary Provisions (where applicable, see TPM for exceptions)	120
6.1.2	Security.....	120
6.1.3	Construction and Coordination	121
6.1.4	Base Building Finishes	122
7.0	EXHIBITS TERMINAL A	122
7.1	Provisions Summary- Terminal A.....	122
7.2	DFW Airport Provided Responsibility Matrix- Terminal A	126

TABLE OF CONTENTS

7.3	Concessions Service Matrix- Terminal A	131
7.4	Ramp Level Plan Terminal A.....	136
7.5	Concourse Level Plan Terminal A.....	137
8.0	EXHIBITS TERMINAL B	138
8.1	Provisions Summary- Terminal B	138
8.2	DFW Airport Provided Responsibility Matrix- Terminal B.....	141
8.3	Concessions Service Matrix- Terminal B.....	147
8.4	Ramp Level Plan Terminal B	150
8.5	Concourse Level Plan Terminal B	151
9.0	EXHIBITS TERMINAL C	152
9.1	Provisions Summary- Terminal C	152
9.2	DFW Airport Provided Responsibility Matrix- Terminal C.....	155
9.3	Concessions Service Matrix- Terminal C	160
9.4	Ramp Level Plan Terminal C	163
9.5	Concourse Level Plan Terminal C	164
10.0	EXHIBITS TERMINAL E	165
10.1	Provisions Summary- Terminal E	165
10.2	DFW Airport Provided Responsibility Matrix- Terminal E.....	168
10.3	Concessions Service Matrix- Terminal E.....	173
10.4	Ramp Level Plan Terminal E	176
10.5	Concourse Level Plan Terminal E	177
11.0	Schedules.....	178
11.1	Heat Loss Schedule	180
11.2	Heat Gain Schedule.....	182
11.3	Electrical Review Schedule	184
11.4	DFW International Airport ETAM Department Vent/Hood Data Form	186

TABLE OF CONTENTS

12.0	Specifications	191
	PART 1 - GENERAL	193
	PART 2 - PRODUCTS	196
	PART 3 - EXECUTION.....	200

1.0 INTRODUCTION

1.1 Introduction

The purpose of the DFW Tenant Design Manual (TDM) is to familiarize our potential tenants with the various special conditions of Terminals A, B, C, and E and explain how to design and build new concession spaces within the newly redesigned terminals at DFW International Airport. This manual will provide your design and construction team with a guideline for preparing and submitting plans for review and approval.

Note that our intent is to guide your team through our process, not completely control your design. The design criteria are meant to create a specific atmosphere or image in certain zones throughout the Airport. **Tenants are encouraged to be innovative and creative in the design and layout of their spaces.** The Airport does not intend to design your space, but will approve submittals in order to maintain a consistently high level of design.

Dimensions and details shown in this manual of existing building conditions are for reference only. It is the responsibility of the tenant to confirm existing conditions and to document any deviation in the existing condition details for DFW Concessions review and approval.

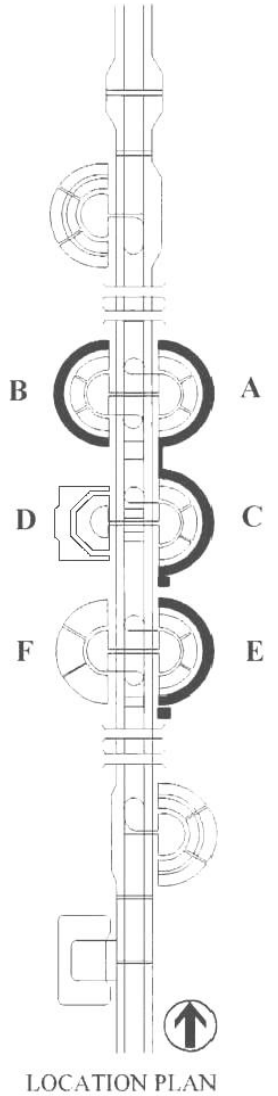

1.2 **Definitions**

Following are words used throughout the Tenant Design Manual and their meanings as they refer to concession development at DFW Airport.

ADA	Americans with Disabilities Act
A.F.F.	Above Finished Floor
AHJ	Authority Having Jurisdiction
Airport	Dallas/Fort Worth International Airport
Airside	The secured side of the terminal
AOA	Air Operations Area
A.O.L.'s	All Other Airlines
Artery Wall	Glass wall located along inside edge of concourse
ASHRAE	American Society of Heating, Refrigerating and Air-Conditioning Engineers
Building Permit	Permit to commence construction issued by DFW Code Compliance based on approved plans and specifications
CAD	Computer Aided Design
CCTV	Closed Circuit Television
Concessionaire	Tenant or lessee within the airport terminal that provides food, beverage, or retail services
Concourse	The passenger circulation corridor with airside and landside separation
Contractor	General Construction contractor who holds the building permit and executes the construction shown on the approved contract documents for the tenant or the Airport

DFW Code Compliance	Airport authority having jurisdiction over all matters pertaining to establishment and enforcement of building and construction requirements and standards at DFW International Airport
DFW Design Criteria Manual	Guidelines and parameters for any design and construction within the boundaries of the Airport, www.dfwairport.com/concessions
Equipment	Fixed (attached) or moveable equipment, trade fixtures, or mechanical components owned by the tenant and operated within the leased area that is necessary for the conduct of business.
Fan Coil Boxes	Cooling units to be used for supplemental air connected to the Airport's 2-pipe system
Furr-down	A ceiling or part of a ceiling that is lower than the primary ceiling structure
Haunch	The angled "bracket" portion of the existing airport concrete columns
Identity Control Zone (ICZ)	The transition areas at the storefront of the tenant lease space where special design consideration is required. Elements within the Identity Control Zone must comply with the Manual guidelines for storefront, lighting, signage and merchandising
ITS	Information Technology Services
IED	Innovative Electronic Designs
Landside	The unsecured side of the terminal and associated roadways and parking structures
Lease Outline Document (L.O.D.)	Document showing the tenant's space boundaries and area
Lease Space Reference Number	Alphanumeric designation or "address" specific to each tenant within the terminal

Neutral Frame	A metal frame at the storefront opening that provides the transition from base building to tenant finishes
NFPA	National Fire Protection Association
Phenolic panel	High-impact laminate panels
psf	pounds per square foot
Shell Space	Unfinished building area
SkyLink Node	Multiple food/beverage and retail tenants grouped near SkyLink station entries
Soffit	Horizontal surface of a furr-down assembly
Special Feature Zone	An area where they are allowed to construct 3d signage elements that extend past the neutral frame.
Storefront Enclosure	The public façade within the neutral frame that is maintained by the tenant
Supplemental Signage	Additional signage provided by the tenant, which must be approved by the Airport, signage must comply with the Tenant Design Manual guidelines
TAS	Texas Accessibility Standards
TBD	To be determined
TDM	Tenant Design Manual
Tenant	Lessee or concession operator
Tenant Improvements	The permanent improvements necessary to prepare lease space for occupancy. These may include walls, floors, lighting, and HVAC
Tenant Lease Area	The area within the lease perimeter, defined by the lease line
Tenant Project Manager (TPM)	The single point of contact in the DFW Airport Concessions Dept. for tenants on issues of design and construction

T.O.	top of
UON	Unless Otherwise Noted
VAV	Variable Air Volume air handling unit boxes to be connected to the existing Airport air delivery system within the tenant's space

1.3 Design Reference Outline

Following is a concise design reference outline for this Tenant Design Manual. New Tenants, Designers, Architects and Engineers may use this section to quickly find their space and the design and permitting requirements associated with that specific space.

1. Defining your specific space.

- a. Find your location using the alphanumeric Lease Space Reference Number (see example below) found on LOD and using the *Exhibit-Ramp Level Plan* or *Exhibit- Concourse Level Plan* associated with your terminal.
- b. To determine your specific space conditions (Architectural, IT and MEP), locate *Exhibit- Concessions Service Matrix*. If your concession type is different than shown, please contact the DFW Concessions Department.

Example alphanumeric Lease Space Reference Number in Terminal

A

A-2-010C-A01

- (A) Terminal Designation (A, B, C or E)
- (2) Level (1 or 2)
- (010) Numerical Designated Column Line
- (C) Alphabetical Designated Column Line
- (A/L) Airside/Landside
- (01) Multiple Spaces at Designated Column Line (01, 02...)

2. Defining your design condition.

- a. There are 3 distinct design conditions identified in this Tenant Design Manual, A – In-line, B – Freestanding, and C – Corner, with multiple applications within each Design Condition dependent upon location.
- b. **Determine your designated design condition by referring to the “Architectural” heading in the “Concessions Service Matrix” for your Terminal. Then refer to Section 2.2, “Design Conditions.”**

3. Defining your design criteria.

- a. *Section 3.0, "Design Criteria"* provides the information to create and implement all submittals and contract documents needed to complete the design and construction of your new tenant space;
 - 1) *Section 3.1, "Lease Space Guidelines,"* architectural information essential for designing your space to meet basic DFW criteria.
 - 2) *Section 3.3, "Food and Beverage Tenants,"* information in addition to the Lease Space Guidelines essential for designing a food and beverage space to meet basic DFW criteria.
 - 3) *Section 3.10, "Signage Criteria,"* Lighting Criteria, Acoustics and Public Address, Mechanical Electrical and Plumbing (MEP) Requirements, Fire Protection and Life Safety, Telephone/Data - information in addition to the architectural data provided in the Lease Space Guidelines essential for completing the design and construction of your new tenant space and to meet basic DFW criteria.
 - 4) *Section 3.11, "Roof Penetrations,"* information and restrictions about any needed roof penetrations your new tenant space may require.

4. Defining your responsibilities and procedures.

- a. *Section 4.1, "Codes and Standards,"* information about, but not limited to building codes, licenses and permits, sustainability, accessibility and the DFW Design Criteria Manual to help you create and implement all submittals and contract documents needed to complete the design and construction of your new tenant space.
- b. *Section 5.0, "Design Review and Code Submittal,"* provides necessary information about the submittal procedure. You will find information about the 35% review, 95% review, the permit document submittal and the final review process.

1.4 Codes and Standards

The tenant will be responsible for reviewing, understanding, and implementing, as part of their design, all applicable codes and jurisdictions, including but not limited to: local, state and federal laws, statutes, orders, code and code ordinances and regulations applicable to the work. Review of the tenant's documents by the DFW Concessions Department does not include code compliance and does not relieve the tenant of responsibility to satisfy all applicable regulations. Due to the duration of phasing for the airport redevelopment, all new tenants must verify applicable codes and standards prior to the start of any project. All tenants, architects, engineers, and contractors must be familiar with this **DFW Concessions Tenant Design Manual** and the applicable sections of the current edition of the **DFW Design Criteria Manual** in addition to the adopted Airport codes. **(Reference www.dfwairport.com as amended)**

IBC International Building Code
IPC International Plumbing Code
IMC International Mechanical Code
IECC International Energy Conservation Code
IFC International Fire Code with DFW Construction and Fire Prevention Standards Resolution and Amendments
NEC National Electrical Code

ADA Americans with Disabilities Act
TAS Texas Accessibility Standards of the Architectural Barriers Act, reference: <https://www.license.state.tx.us/ABProjectRegistrationOnline>

Refer to *Section 4.0, "Responsibilities and Procedures,"* for detailed information on codes and standards. All tenant improvements are subject to the approval of the TPM and the DFW Code Enforcement Department.

2.0 EXISTING BUILDING CONDITIONS

DFW International Airport exhibits a strong, comprehensive architectural concept that has been respected by the Board throughout years of expansion. It is important to maintain the architectural integrity of the Airport in all future development.

The "horseshoe" concept of four terminals - Terminals A, B, C, and E is a systematic radial plan that affects design criteria. Although the four terminals are similar in concept, they were developed separately and have architectural and structural differences. Those differences must be accommodated in varying ways so that tenant storefronts conform to the general design concept of the terminal.

2.1 Terminals A, B, C & E

2.1.1 Ramp Level

The ramp level consists of the AOA, ground service and support personnel for the airport and various airlines associated with each terminal, baggage handling and security entities.

Food and Beverage tenants having cooking facilities with "cooking oil management" concerns, shall find access elevators leading to designated "oil reclamation" areas on the Ramp and Concourse plans provided for each terminal.

Terminals may also have a designated service elevator and security check point for tenant deliveries located on their ramp level plan.

2.1.2 Concourse Level

The concourse is characterized by open departure lounges on airside and concessions grouped in free-standing units at each SkyLink station. Additional concessions are located along the Concourse walkway. Along the landside wall of the concourse walkway will be a continuous storefront wall (referred to as the "artery wall"), broken by "wedges," in order to provide continuity to the Concourse. Concessions are also located on the airside of the Concourse walkway in limited locations.

At the SkyLink nodes of Terminal A, the continuous storefront wall will move to the face of the column haunches. In these locations the columns and haunches will be concealed by new Phenolic panels.

"Wedges" are a result of the radial configuration of the terminal buildings. Typically, the wedges have lower ceilings and are used for wayfinding signage as well as mechanical and plumbing plenums to adjacent areas.

2.2 Design Conditions

The design image of concession tenant spaces is created through standard neutral frame details, common storefront requirements, and respective storefront and signage zones. These design elements create a consistent image for the users of DFW while allowing tenants to express their identity within the Identity Control Zone (ICZ) space. Because each terminal is unique, various design guidelines have been established to achieve a consistent image throughout the airport.

Each lease space will fall into a general design condition outlined on the following pages. The "Responsibility Matrix," will provide for the design conditions associated with each lease space, **(Refer to Sections 7.2, 8.2, 9.2 and 10.2)**. All storefronts are subject to approval by DFW Concessions.

Design conditions covered in this section include:

- Design Condition A - In-line
- Design Condition B - Freestanding
- Design Condition C - Corner

The Identity Control Zone is not meant to restrict a tenant's branding, although the design must follow and be subject to the Airport's approval process. (Refer to specific design condition for limitations and requirements. Some storefronts may have limitations on allowable elements.) All Identity Control Zones are strongly encouraged to include the following elements, but are not limited to:

Blade Sign (required)	Sign located outside the store enclosure and displayed perpendicular to circulation
Bulkhead Sign (where applicable)	Sign located on designated bulkhead outside of leasehold area
Canopy	Overhead architectural element
Counter	Surface where customers are served and goods are displayed
Display Case	Enclosure (partially or fully enclosed) in which goods are exhibited
Feature Wall	Signage, branding, or any architectural design to characterize space along circulation
Jamb Feature	Similar to a feature wall but along the vertical jamb of the neutral frame, facing perpendicular to the circulation

3-D Objects

Elements for branding and décor

Railing

Barrier between seating or display area and terminal spaces (e.g.: hold lounges and concourse circulation)

Soffit

Finished underside of leasehold space beyond neutral frame

Reference Section 1.3, "Design Reference Outline" to identify designated design condition



LOCATIONS OUTSIDE THE SKYLINK AREA OF TERMINALS A, B AND E

LOCATIONS WITHIN THE SKYLINK AREA OF TERMINAL A

Diagram of Elements (1 & 2 of 3)
Figure 2.01

- | | | |
|---|--|--|
|  Identity Control Zone |  Feature Wall |  Railing (where applicable, refer to LOD) |
|  Wall Signage |  Bulkhead Signage |  Blade Signage |
|  Jamb Feature |  3-d object |  Counter |
|  Display Case |  Canopy |  Soffit |



Diagram of Elements (3 of 3)
Figure 2.02

 Identity Control Zone	 Feature Wall	 Railing (where applicable, refer to LOD)
 Wall Signage	 Bulkhead Signage	 Blade Signage
 Jamb Feature	 3-d object	 Counter
 Display Case	 Canopy	 Soffit

2.2.1 Design Condition A – In-line

The in-line design conditions are distinguished by a standard neutral frame, Identity Control Zone, and blade signage zone. The in-line conditions occur along both sides of the concourse walkway. Architectural conditions vary depending on location of leasehold. Refer to design condition diagrams for more information.



Example of Design Condition A1
Figure 2.03

2.2.1.1 Design Condition A1 – In-Line, Single Bay with Neutral Frame

Design condition A1 is located along both sides of the main concourse where a tenant occupies one structural bay of the terminal. The neutral frame is emphasized by premium finishes that follow along the main concourse walkway. Tenants are encouraged to make use of the Special Feature Zone, an area where they are allowed to construct 3d signage elements that extend past the neutral frame.



Diagram – Design Condition A1
Figure 2.04

Required:

Identity Control Zone Blade Signage

Elements in Identity Control Zone may or may not include:

 Feature Wall	 Soffit	 Counter
 Jamb Feature	 Canopy	 3-d object
 Display Case		

Design Condition A1 –In-Line, Single Bay with Neutral Frame

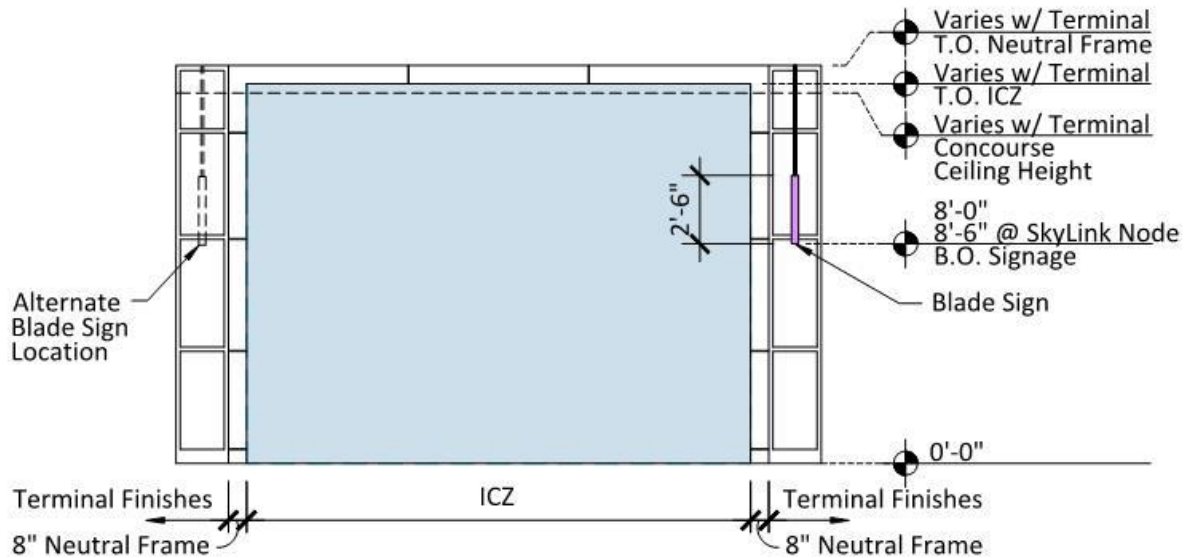

Elevation – Design Condition A1
Figure 2.05

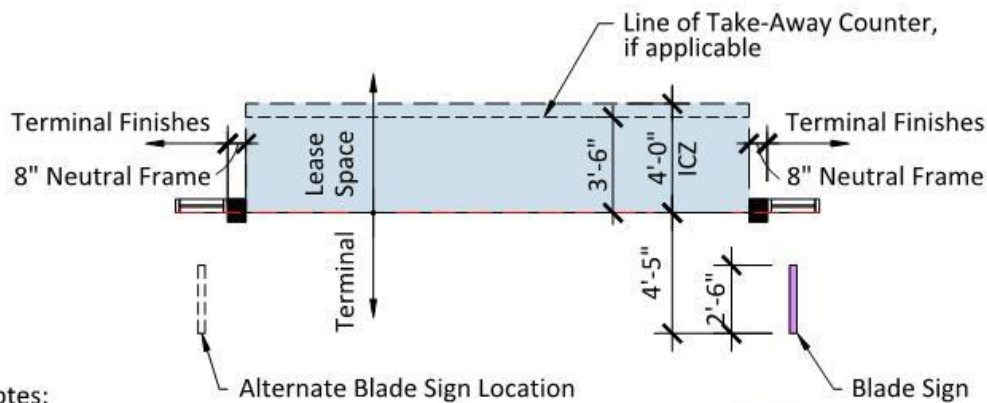

General Notes:

1. Refer to L.O.D.
2. MEP and Structure not shown. Field verify base building prior to any design and construction.

- Identity Control Zone (ICZ)
- Blade sign provided & located by DFW @ center of right sidelight or center of left sidelight. Placement will be determined by Terminal design conditions.

Plan – Design Condition A1
Figure 2.06

Design Condition A1 – In-Line, Single Bay with Neutral Frame

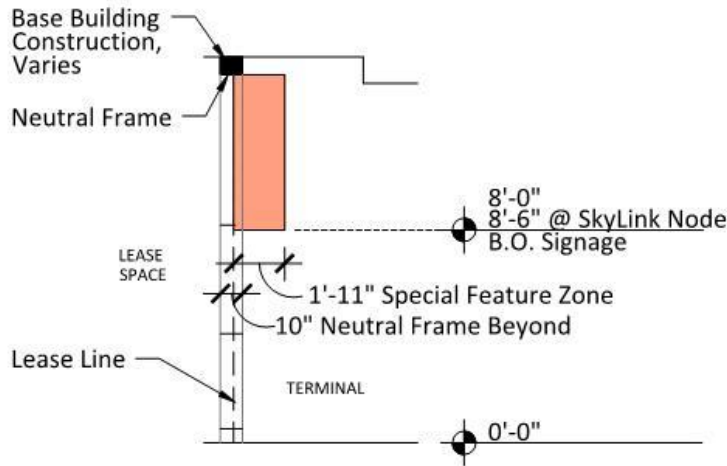

Special Feature Zone Beyond

- Self supporting special feature.
- Align with bottom of blade sign and must not extend above or past the sides of the neutral frame.

Section – Design Condition A1, Special Feature Zone
Figure 2.07

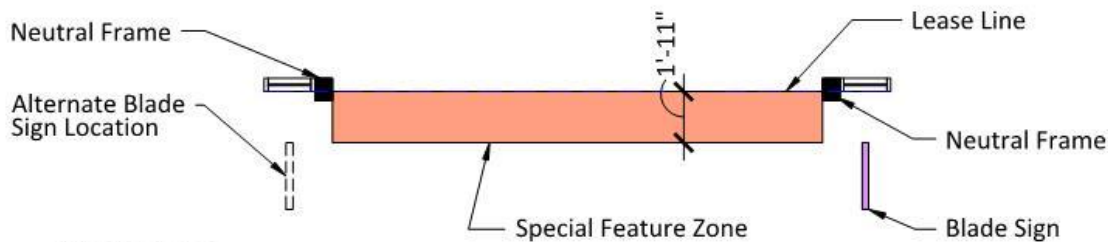

General Notes:

1. Refer to L.O.D.
2. MEP and Structure not shown. Field verify base building prior to any design and construction.

- Special Feature Zone
- Blade sign provided & located by DFW @ center of right sidelight or center of left sidelight. Placement will be determined by Terminal design conditions.

Plan – Design Condition A1, Special Feature Zone
Figure 2.08

Design Condition A1 – In-Line, Single Bay with Neutral Frame

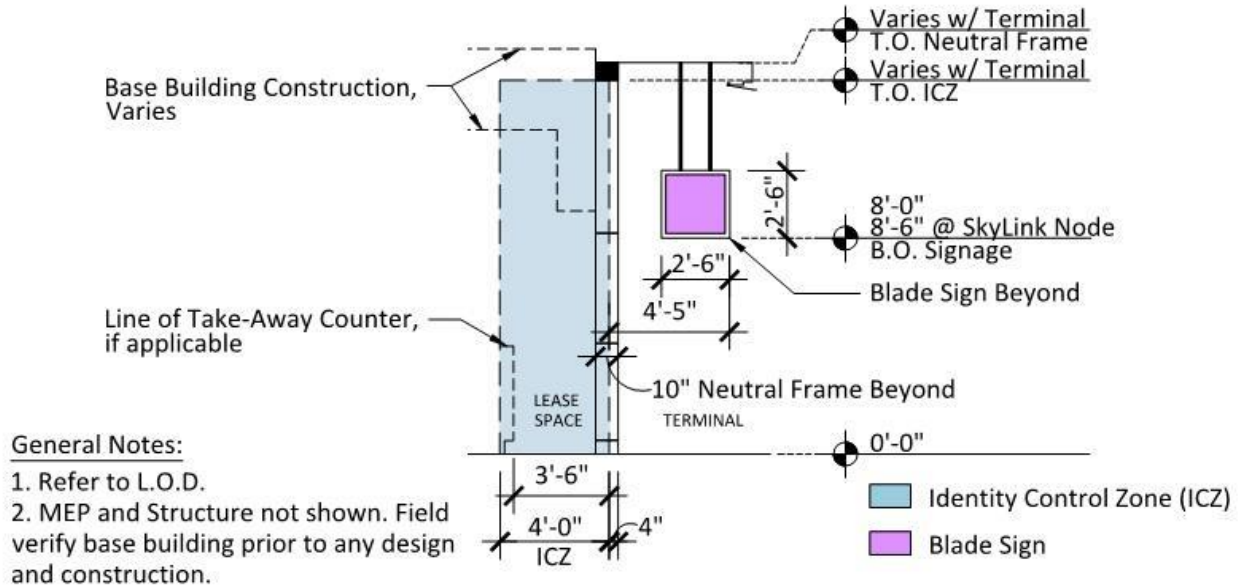

Section – Design Condition A1
Figure 2.09

For additional information:

- Reference Section 3.1, “Lease Space Guidelines”**
- Reference Section 3.3, “Food and Beverage Tenants”**
- Reference Section 3.3.2, “Take-Away Counters” (if applicable)**
- Reference Section 3.3.3, “Grab & Go Units” (if applicable)**
- Reference Section 3.5, “Signage Criteria”**
- Reference L.O.D.’s for specific leasehold details**

**2.2.1.2 Design Condition A2 – In-Line, Default (or Optional)
Multi-Bay with Neutral Frame**

Similar to design condition A1, the A2 condition has a neutral frame emphasized by premium finishes that follows along the main concourse walkway. Condition A2 is located in the main concourse where the tenant extends across multiple bays. The Default Multi-Bay condition will be a full opening, uninterrupted neutral frame spanning across the occupied bays. Any intervening column(s) must be finished on all sides. The tenant should approach the column finishes as an opportunity for a holistic storefront design. As an alternative, the tenant may use the Optional Multi-Bay condition in which the intervening column is the terminal standard finish (phenolic panel with a vertical neutral frame on each side of the column). Tenants are encouraged to make use of the Special Feature Zone, an area where they are allowed to construct 3d signage elements that extend past the neutral frame.

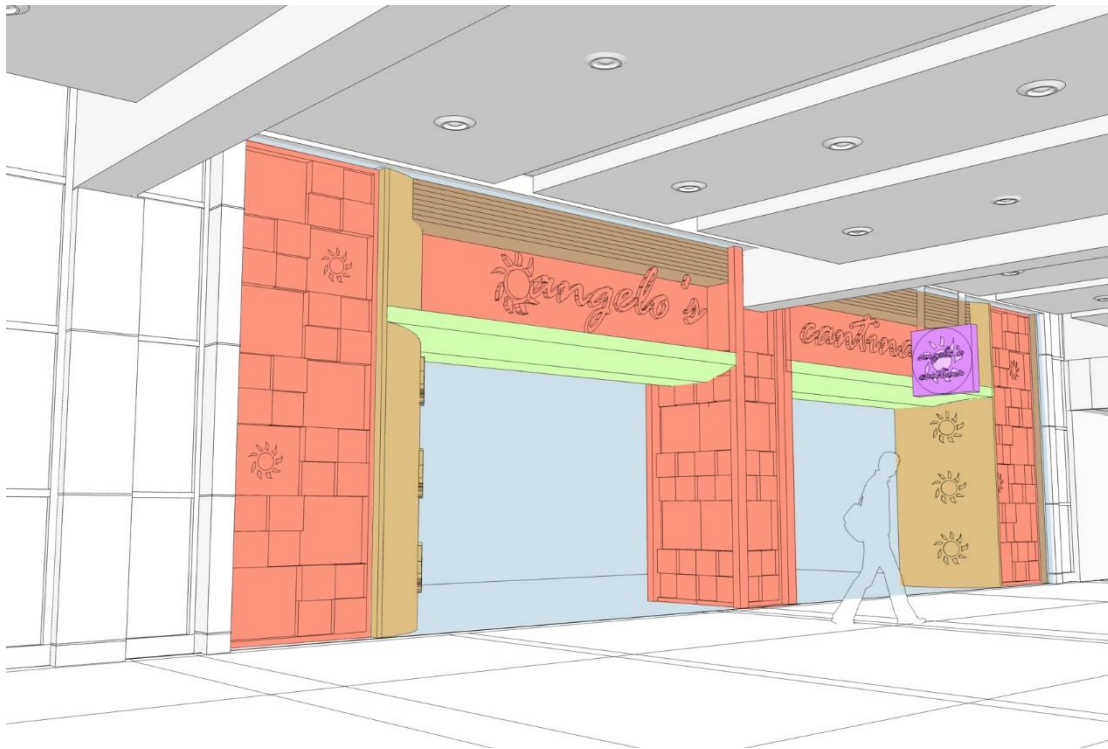

- Required:
- Identity Control Zone
 - Blade Signage
- Elements in Identity Control Zone may or may not include:
- Feature Wall
 - Soffit
 - Counter
 - Jamb Feature
 - Canopy
 - 3-d object
 - Display Case

Diagram – Design Condition A2 - Default
Figure 2.10

Design Condition A2 – In-Line, Multi-Bay with Neutral Frame (Default Condition)

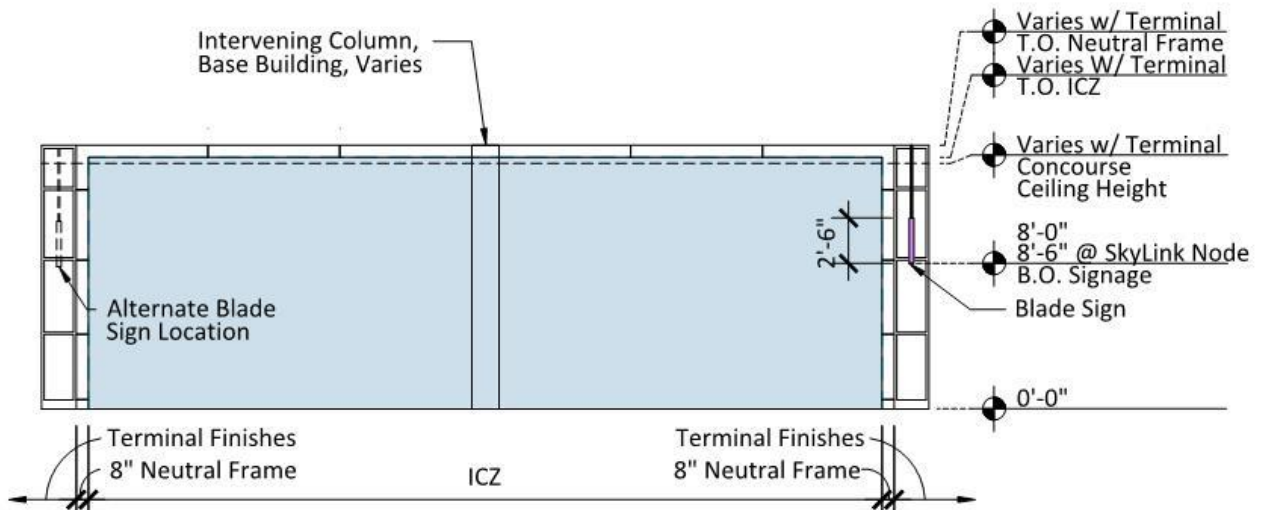

Elevation – Design Condition A2 - Default
Figure 2.11

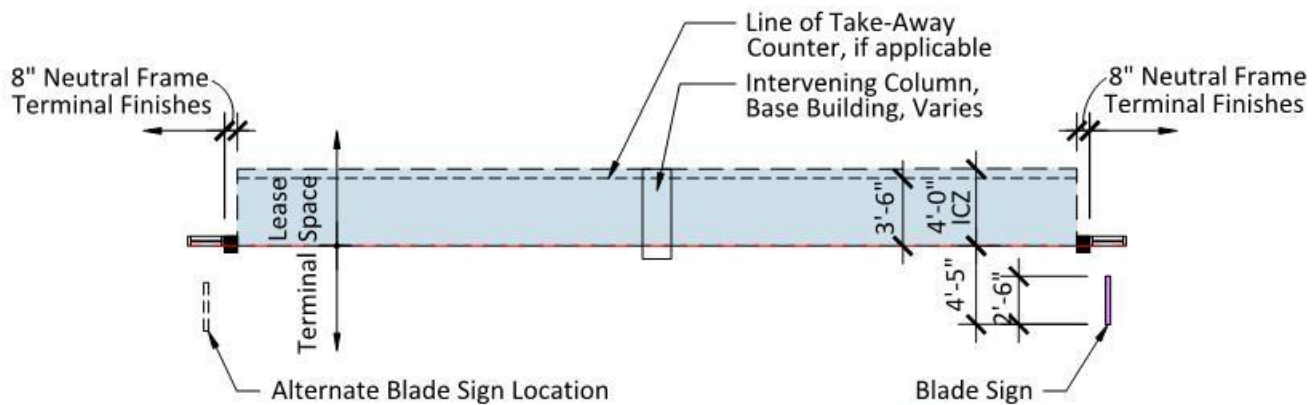

General Notes:

1. Refer to L.O.D.
2. MEP and Structure not shown. Field verify base building prior to any design and construction.

- Identity Control Zone (ICZ)
- Blade sign provided & located by DFW @ center of right sidelight or center of left sidelight. Placement will be determined by Terminal design conditions.

Plan – Design Condition A2 - Default
Figure 2.12

Design Condition A2 – In-Line, Multi-Bay with Neutral Frame (Default Condition)

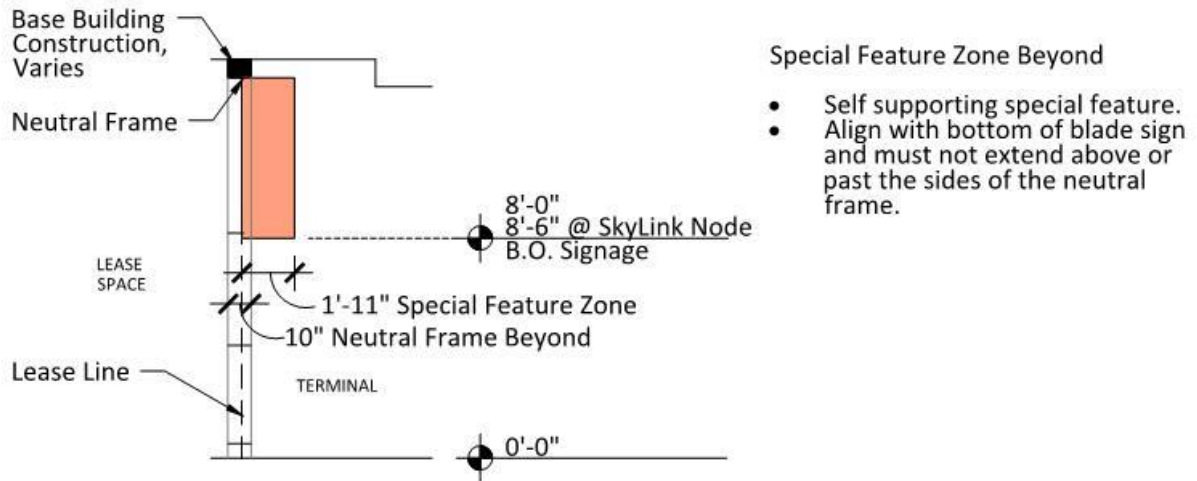

Section – Design Condition A2 - Default, Special Feature Zone
Figure 2.13

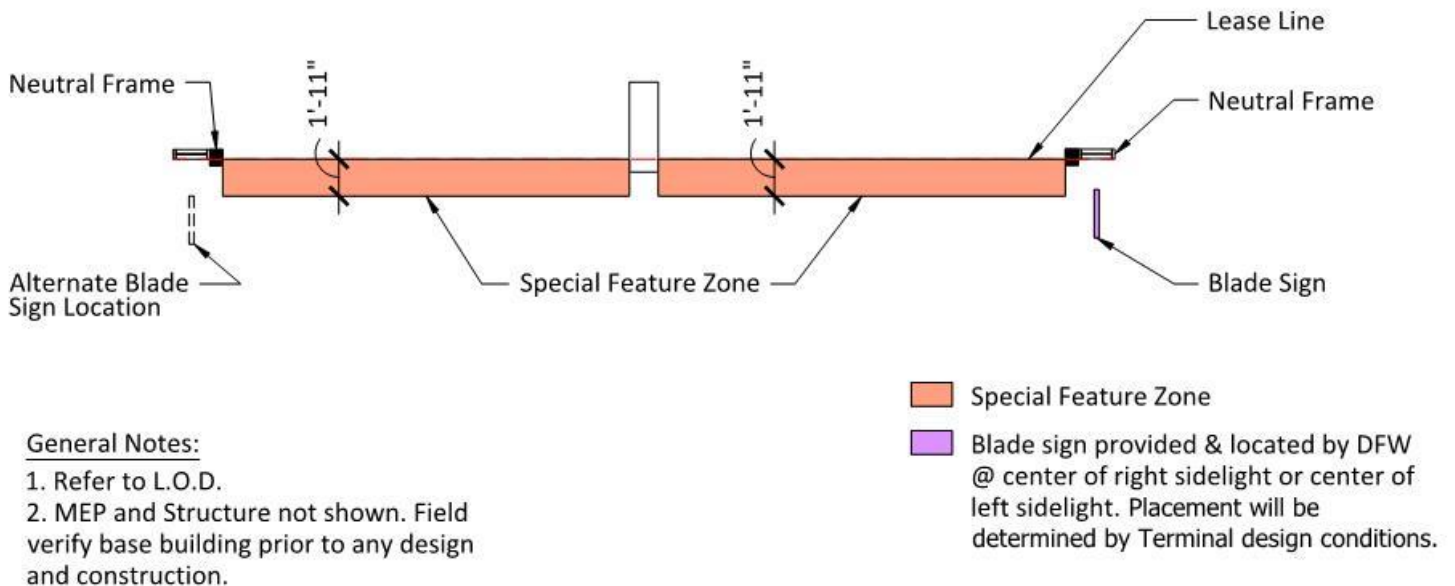

Plan – Design Condition A2 - Default, Special Feature Zone
Figure 2.14

Design Condition A2 – In-Line, Multi-Bay with Neutral Frame (Default Condition)

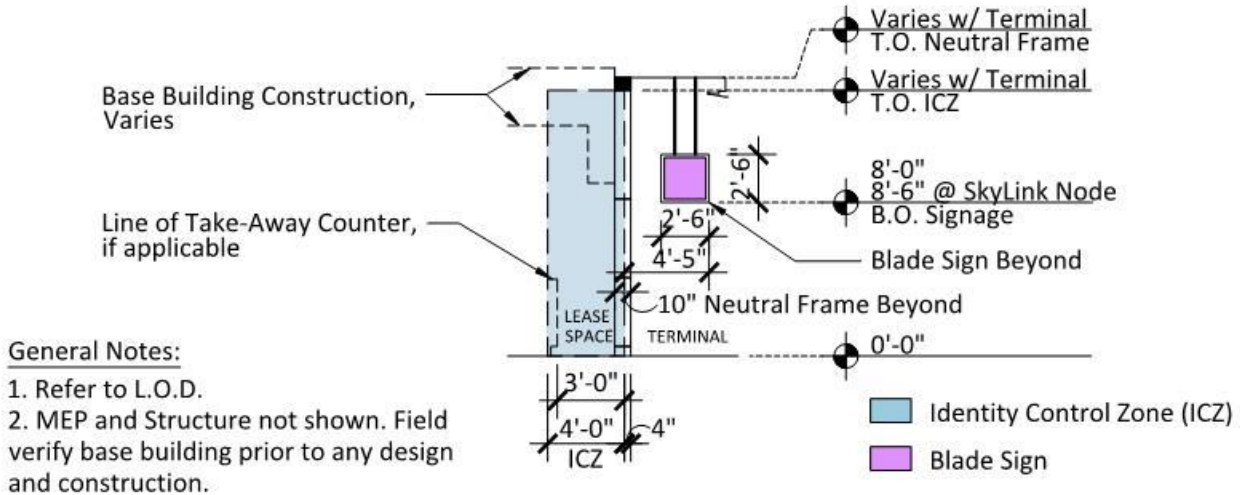

Section – Design Condition A2 - Default
Figure 2.15

For additional information:

Reference Section 3.1, "Lease Space Guidelines"

Reference Section 3.3, "Food and Beverage Tenants"

Reference Section 3.3.2, "Take-Away Counters" (if applicable)

Reference Section 3.3.3, "Grab & Go Units" (if applicable)

Reference Section 3.5, "Signage Criteria"

Reference L.O.D.'s for specific leasehold details

Design Condition A2 – In-Line, Multi-Bay with Neutral Frame (Optional Condition)



Required:



- | | | |
|---|---|--|
|  Identity Control Zone |  Blade Signage | |
| Elements in Identity Control Zone may or may not include: | | |
|  Feature Wall |  Soffit |  Counter |
|  Jamb Feature |  Canopy |  3-d object |
|  Display Case | | |

Diagram – Design Condition A2 – Optional
Figure 2.16

Design Condition A2 – In-Line, Optional Multi-Bay with Neutral Frame (Optional Condition)



Elevation – Design Condition A2 – Optional
Figure 2.17

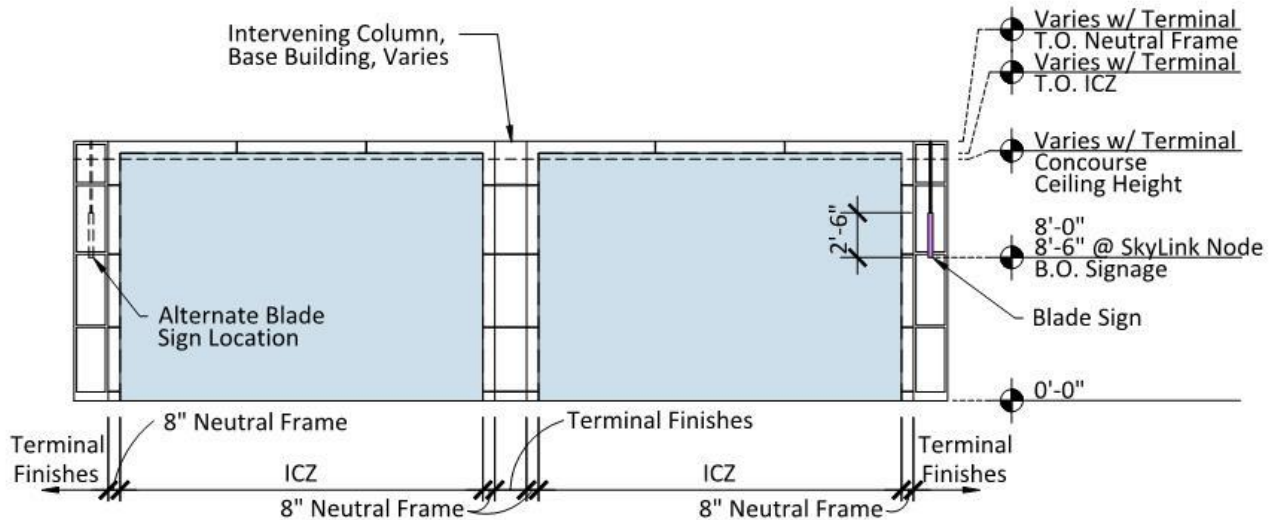
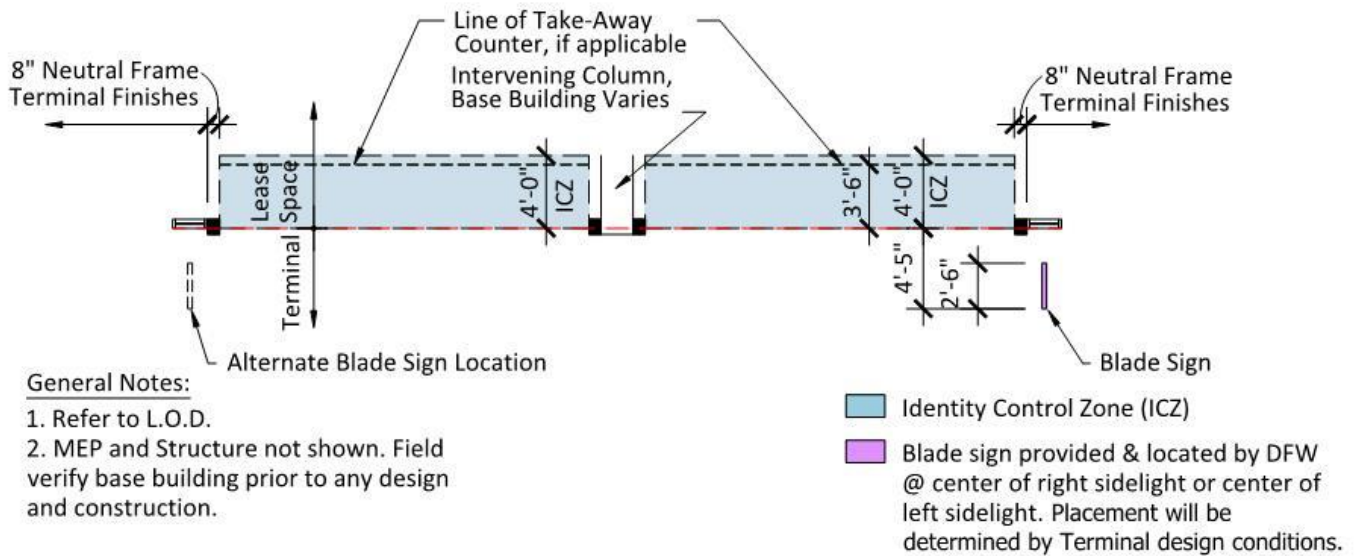

Plan – Design Condition A2 – Optional
Figure 2.18

Design Condition A2 – In-Line, Optional Multi-Bay with Neutral Frame (Optional Condition)

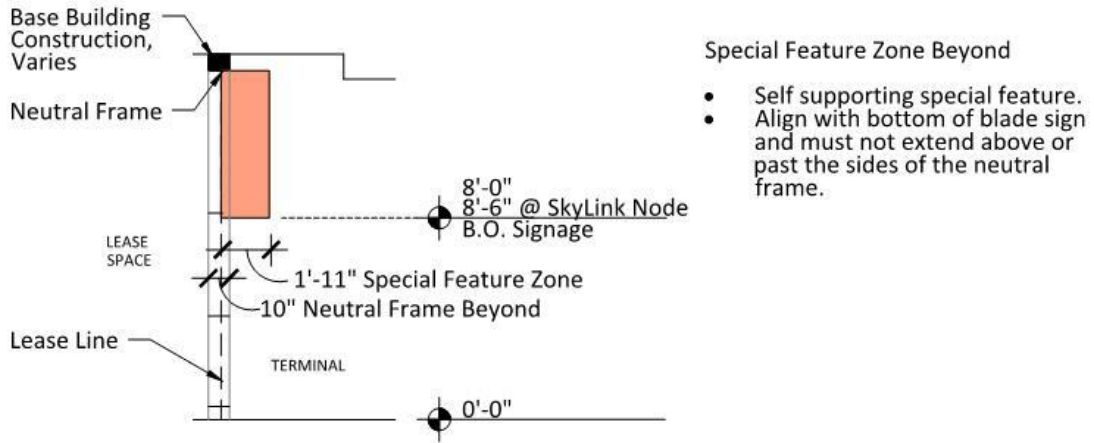

Section – Design Condition A2 – Optional, Special Feature Zone
Figure 2.19

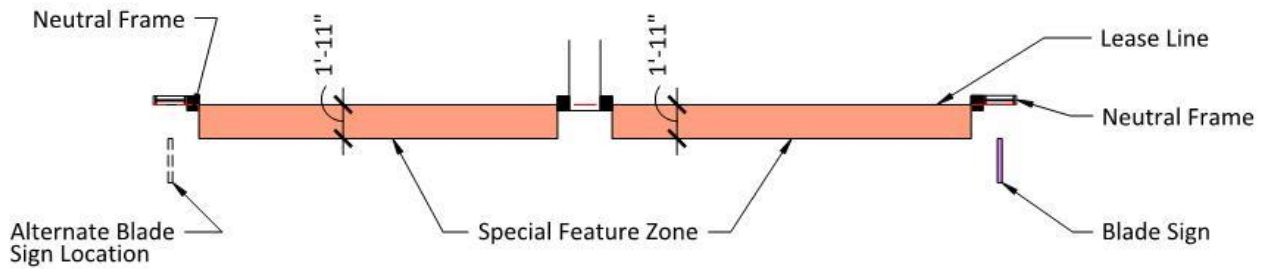

General Notes:

1. Refer to L.O.D.
2. MEP and Structure not shown. Field verify base building prior to any design and construction.

- Special Feature Zone
- Blade sign provided & located by DFW @ center of right sidelight or center of left sidelight. Placement will be determined by Terminal design conditions.

Plan – Design Condition A2 – Optional, Special Feature Zone
Figure 2.20

Design Condition A2 – In-Line, Optional Multi-Bay with Neutral Frame (Optional Condition)

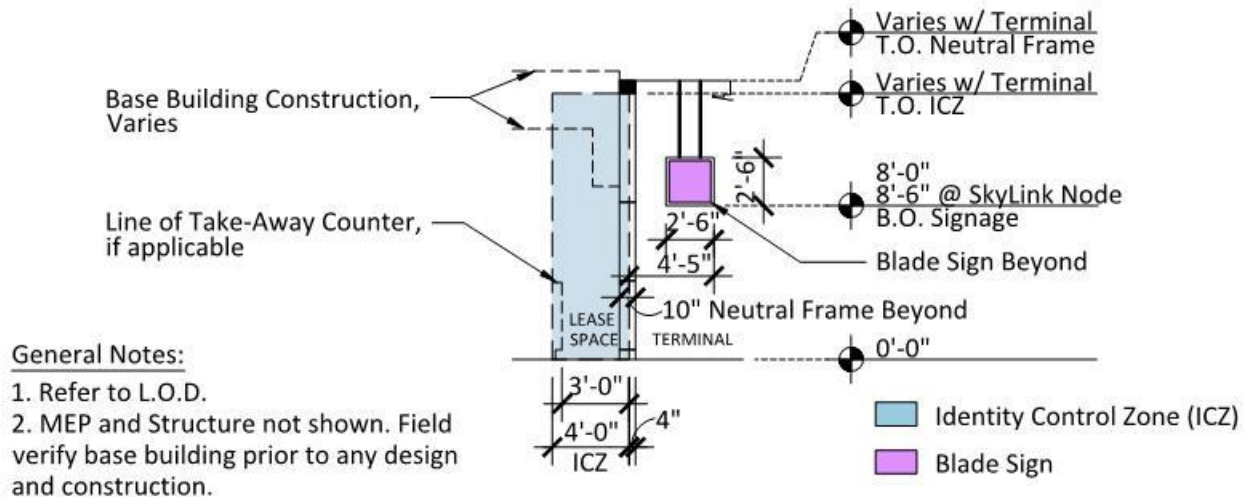

Section – Design Condition A2 – Optional
 Figure 2.21

For additional information:

- Reference Section 3.1, “Lease Space Guidelines”**
- Reference Section 3.3, “Food and Beverage Tenants”**
- Reference Section 3.3.2, “Take-Away Counters” (if applicable)**
- Reference Section 3.3.3, “Grab & Go Units” (if applicable)**
- Reference Section 3.5, “Signage Criteria”**
- Reference L.O.D.’s for specific leasehold details**

2.2.1.3 Design Condition A3 – In-Line, Partial Bay with Neutral Frame

Design Condition A3 is similar to the A1 condition, but the leasehold occupies a partial structural bay of the terminal. Tenants are encouraged to make use of the Special Feature Zone, an area where they are allowed to construct 3d signage elements that extend past the neutral frame.



Required:

Identity Control Zone Blade Signage

Elements in Identity Control Zone may or may not include:

Feature Wall	Soffit	Counter
Jamb Feature	Canopy	3-d object
Display Case		

Diagram of Design Condition A3
Figure 2.22

Design Condition A3 – In-Line, Partial Bay with Neutral Frame

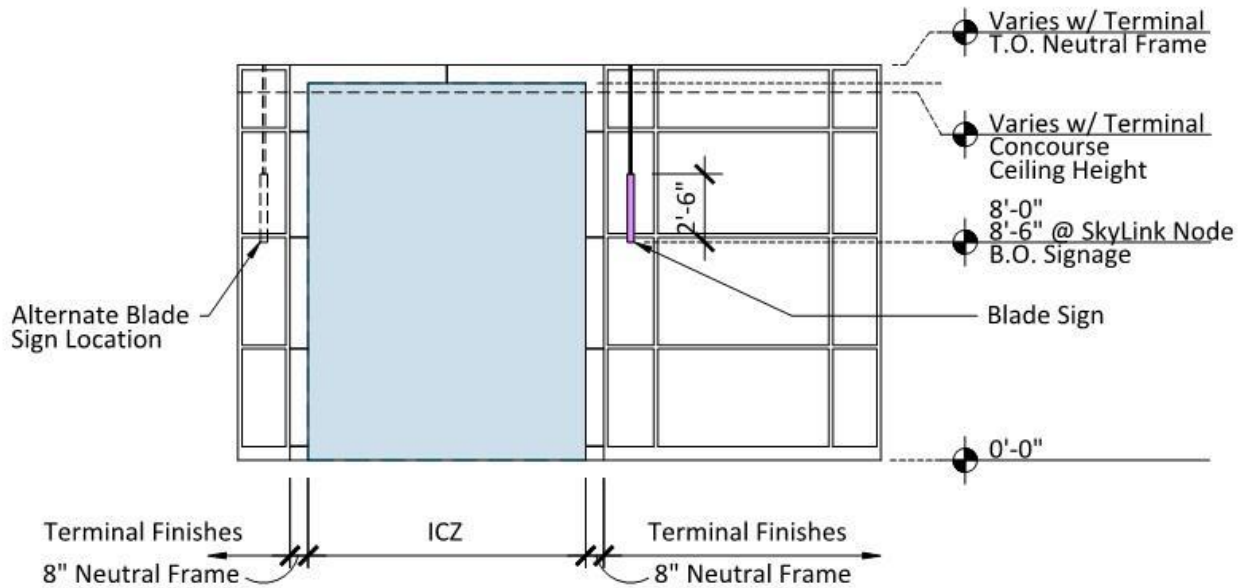

Elevation – Design Condition A3
Figure 2.23

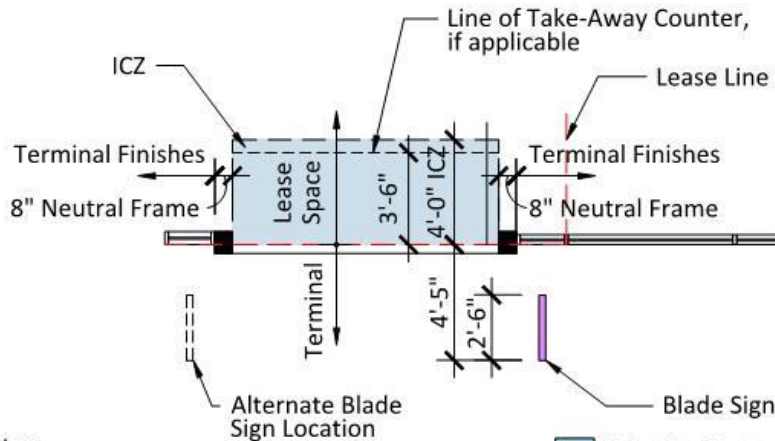

General Notes:

1. Refer to L.O.D.
2. MEP and Structure not shown. Field verify base building prior to any design and construction.

- Identity Control Zone (ICZ)
- Blade sign provided & located by DFW @ center of right sidelight or center of left sidelight. Placement will be determined by Terminal design conditions.

Plan – Design Condition A3
Figure 2.24

Design Condition A3 – In-Line, Partial Bay with Neutral Frame

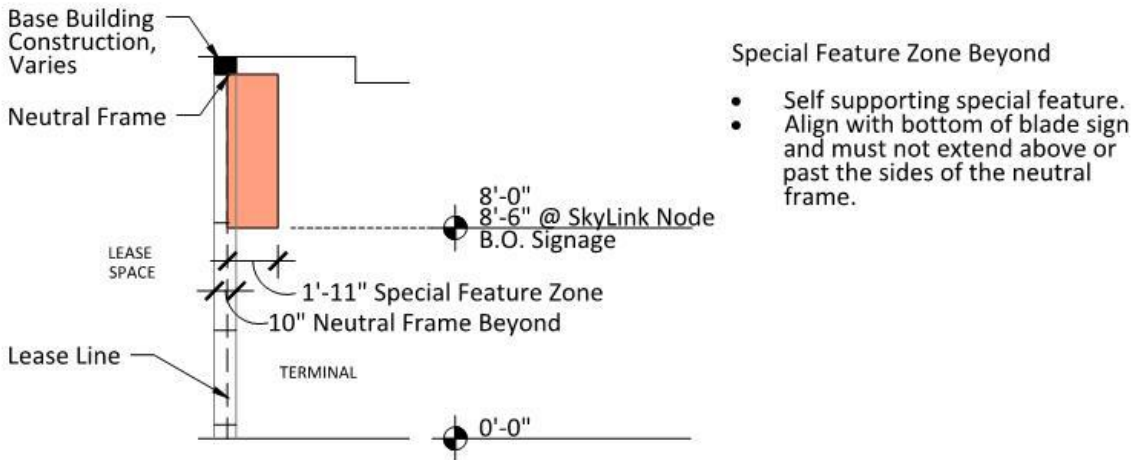

Section – Design Condition A3, Special Feature Zone
Figure 2.25

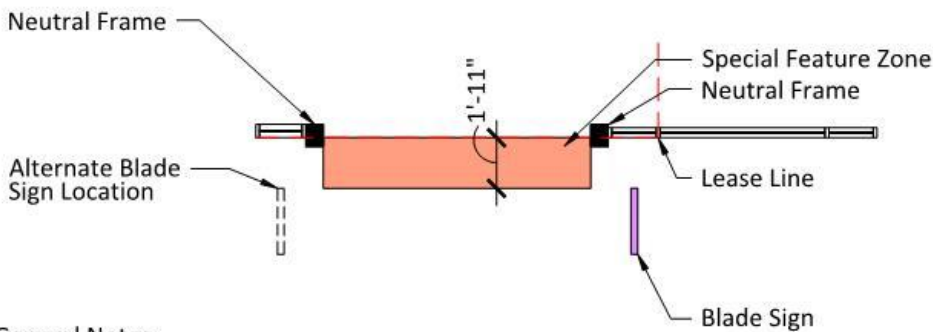

General Notes:

1. Refer to L.O.D.
2. MEP and Structure not shown. Field verify base building prior to any design and construction.

- Special Feature Zone
- Blade sign provided & located by DFW @ center of right sidelight or center of left sidelight. Placement will be determined by Terminal design conditions.

Plan – Design Condition A3, Special Feature Zone
Figure 2.26

Design Condition A3 – In-Line, Partial Bay with Neutral Frame

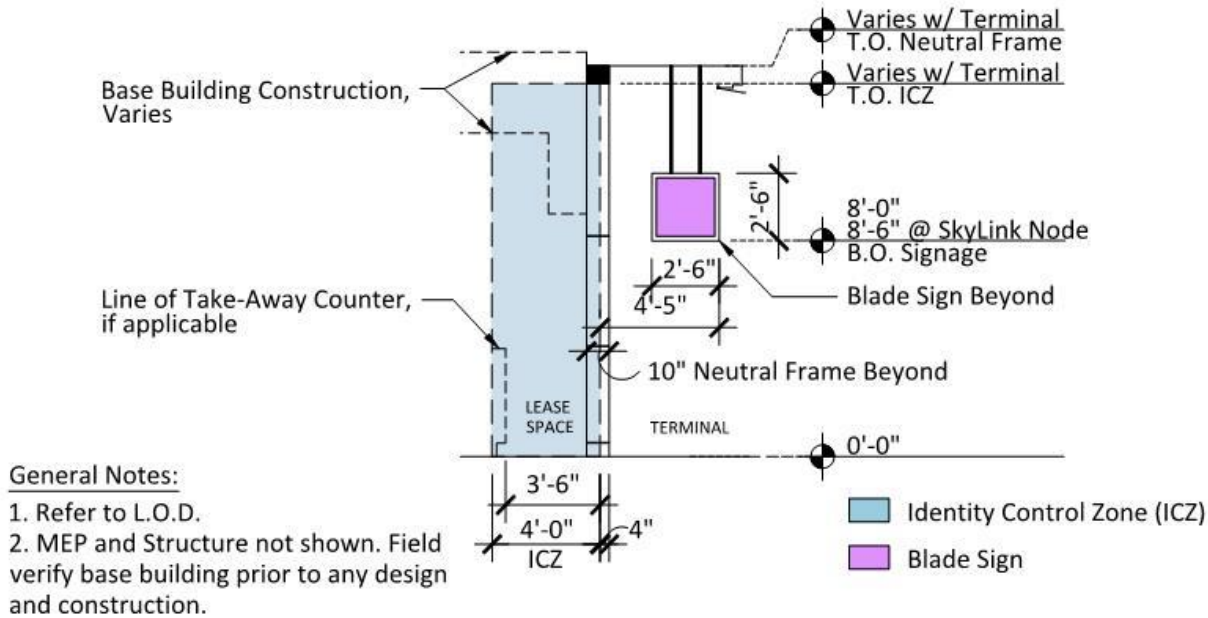

Section – Design Condition A3
Figure 2.27

For additional information:

Reference Section 3.1, “Lease Space Guidelines”

Reference Section 3.3, “Food and Beverage Tenants”

Reference Section 3.3.2, “Take-Away Counters” (if applicable)

Reference Section 3.3.3, “Grab & Go Units” (if applicable)

Reference Section 3.5, “Signage Criteria”

Reference L.O.D.’s for specific leasehold details

2.2.1.4 Design Condition A4, Single Bay Neutral Frame with Revenue Seating or Retail Yard

Design Condition A4 is similar to the A1 condition, but the neutral frame is set back from the concourse corridor. Between the neutral frame and the corridor, the concessionaire has access to space which is enclosed only by a required railing and may be used as revenue seating or as a retail “yard”. Fixtures within that space must be under 42” tall so as not to block visual access to the adjacent spaces. Blade sign will be placed at the concourse corridor in line with other blade signs on the corridor. Tenants are encouraged to make use of the Special Feature Zone, an area where they are allowed to construct 3d signage elements that extend past the neutral frame.

Design Condition A4 – In-Line, Single Bay Neutral Frame

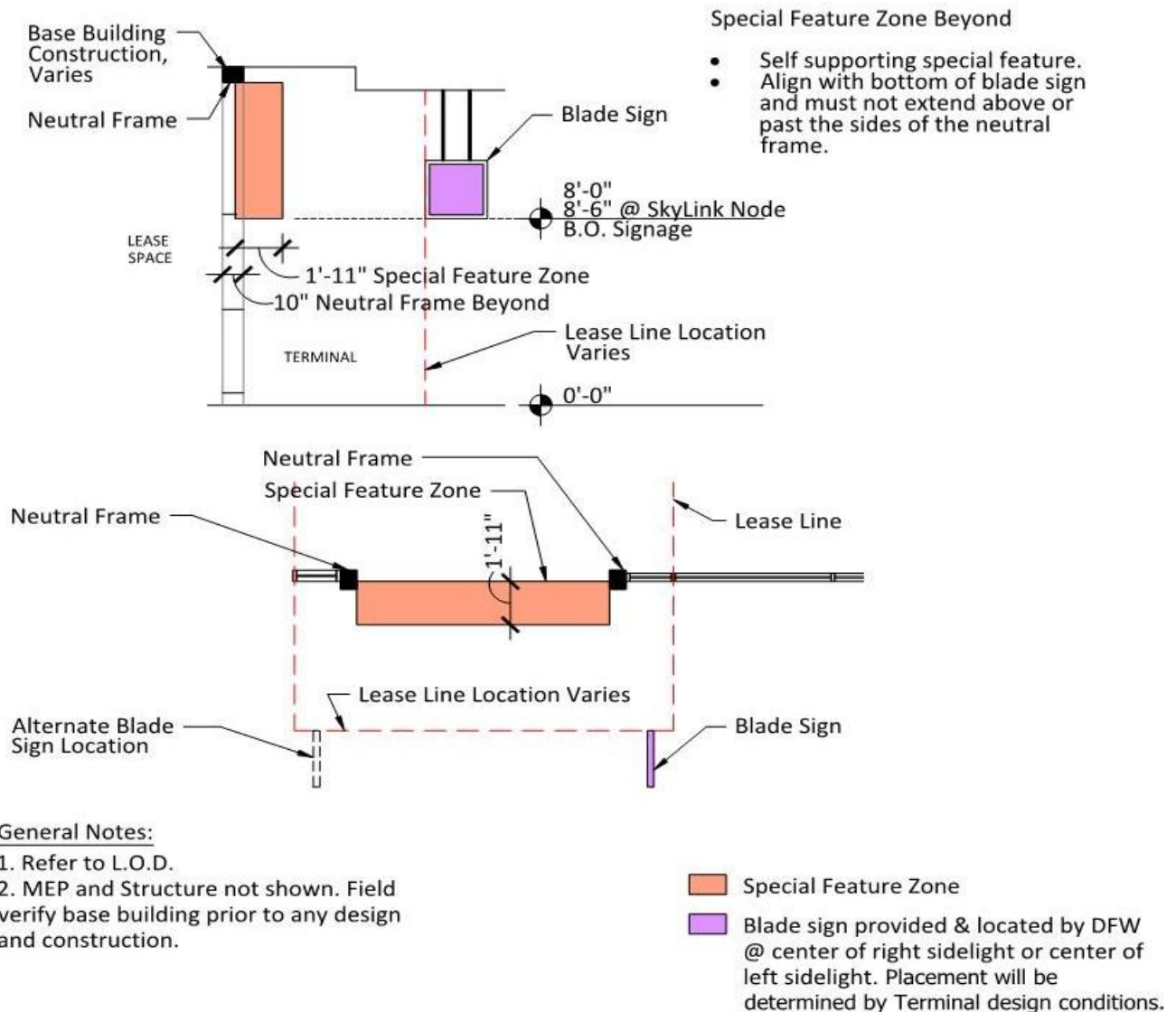

Section – Design Condition A4, Special Feature Zone

Figure 2.31

For additional information:

Reference Section 3.1, "Lease Space Guidelines"

Reference Section 3.3, "Food and Beverage Tenants"

Reference Section 3.3.2, "Take-Away Counters" (if applicable)

Reference Section 3.3.3, "Grab & Go Units" (if applicable)

Reference Section 3.4, "Railings" (if applicable)

Reference Section 3.5, "Signage Criteria"

Reference L.O.D.'s for specific leasehold details

2.2.1.5 Design Condition A5 – In-Line, Wedge 9’-0” Neutral Frame

These storefront conditions are located at the wedges along the concourse walkway, where the ceiling height is at 9’-0”. Due to the low ceiling condition a blade side will be provided on either side of the wedge, right in front of the wedge bulkhead. A blank opaque panel will be provided for each blade sign on the side facing the wedge bulkhead. Opportunity for signage along the terminal wall facing the hold lounge may be available.

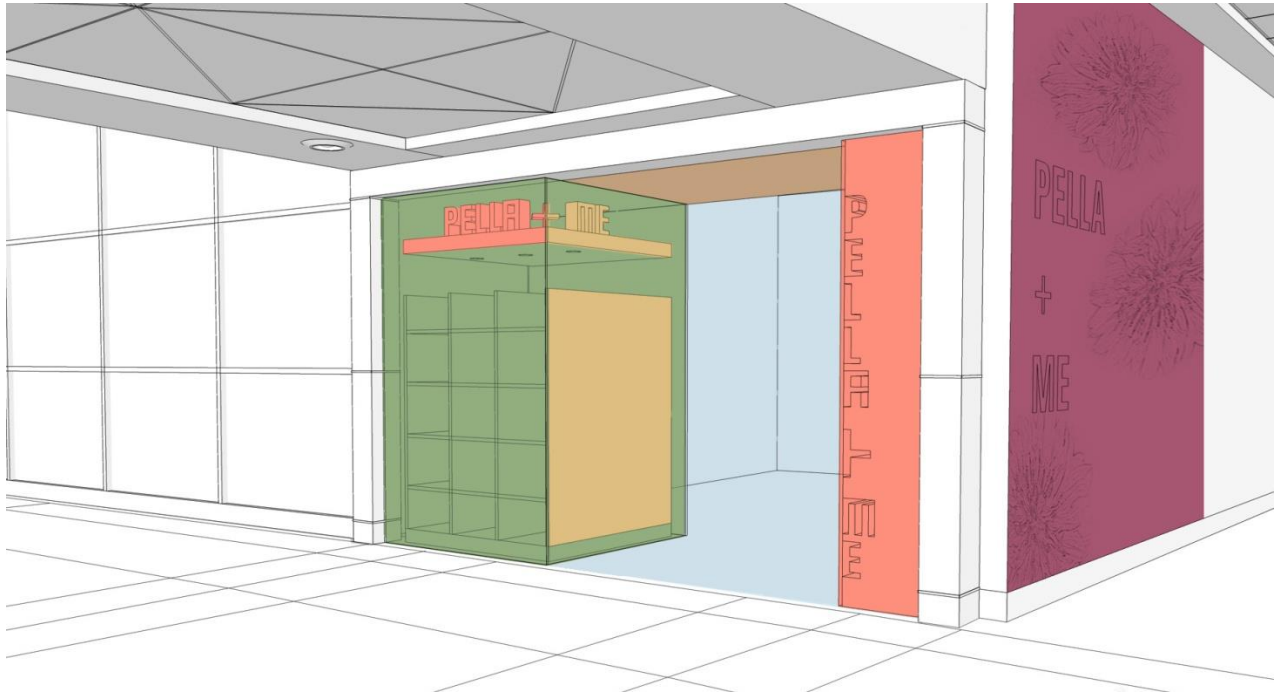

Required:

- | | | |
|--|--|---|
| Identity Control Zone | Blade Signage | Wall Signage |
|--|--|---|

Elements in Identity Control Zone, may or may not include:

- | | | |
|---|---|---|
| Feature Wall | Soffit | Counter |
| Jamb Feature | Canopy | 3-d object |
| Display Case | | |

Diagram of Design Condition A5
Figure 2.34

Design Condition A5 – In-Line, Wedge 9'-0" Neutral Frame

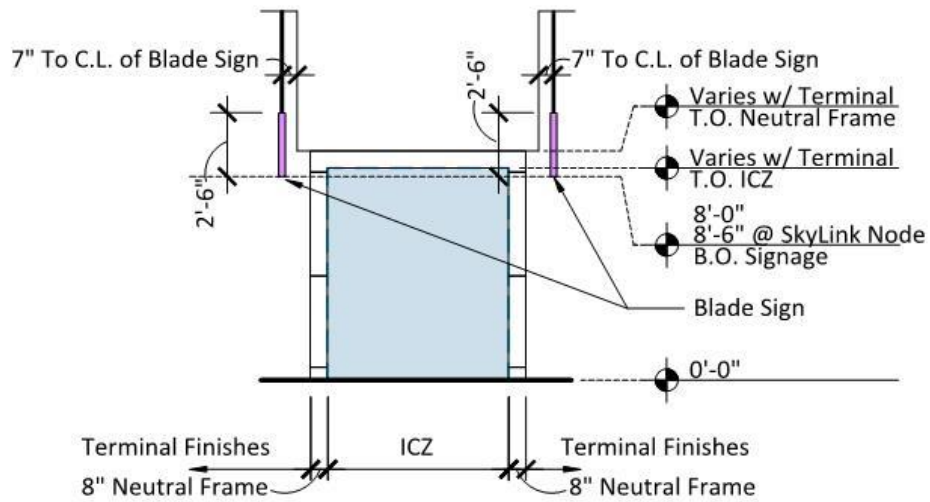

Elevation – Design Condition A5
Figure 2.35

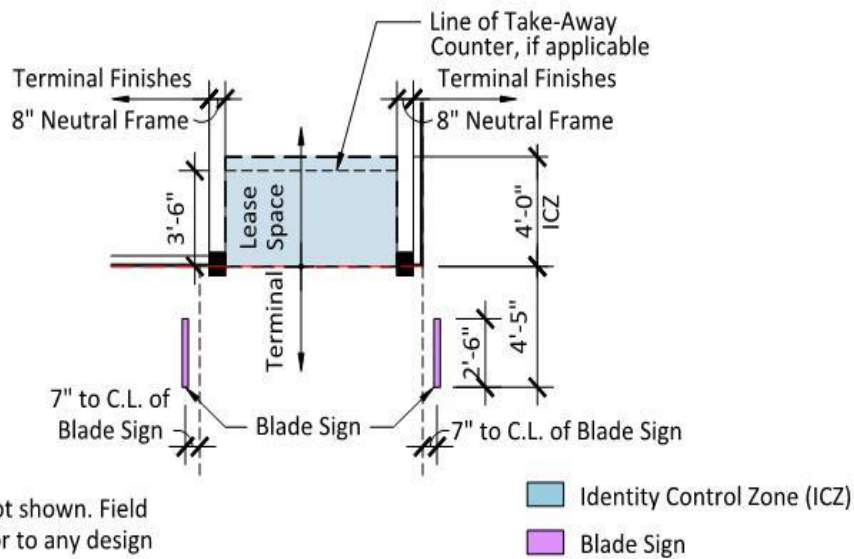

General Notes:

1. Refer to L.O.D.
2. MEP and Structure not shown. Field verify base building prior to any design and construction.

Plan – Design Condition A5
Figure 2.36

Design Condition A5 – In-Line, Wedge 9’-0” Neutral Frame

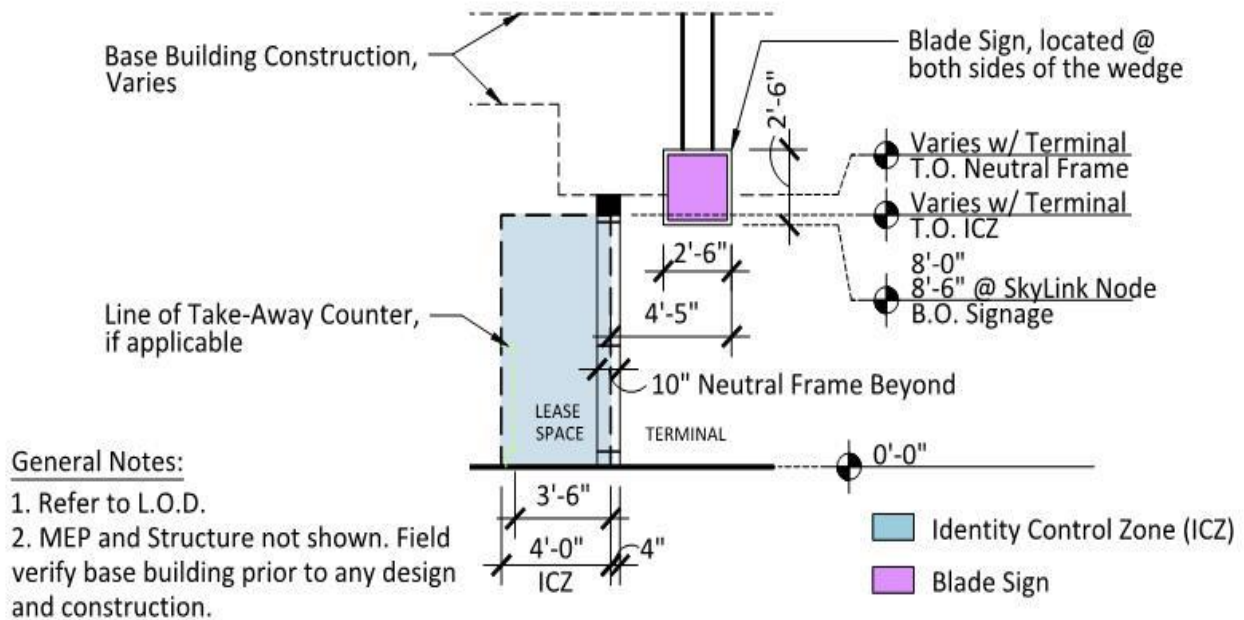

Section – Design Condition A5
Figure 2.37

For additional information:

Reference Section 3.1, “Lease Space Guidelines”

Reference Section 3.3, “Food and Beverage Tenants”

Reference Section 3.3.2, “Take-Away Counters” (if applicable)

Reference Section 3.3.3, “Grab & Go Units” (if applicable)

Reference Section 3.5, “Signage Criteria”

Reference L.O.D.’s for specific leasehold details

2.2.1.6 Design Condition A6 – In-Line, Split-Condition Neutral Frame

Similar to design condition A1, the A6 condition has a neutral frame emphasized by premium finishes, however, that neutral frame is shared by two tenants and will be a full opening, uninterrupted neutral frame spanning across the occupied bay. There may be a solid wall with or without a H.M. door and frame spanning partway across the opening. If there is a wall it will be finished completely. The tenant should approach the wall finishes as an opportunity for a holistic design. A demising wall shall separate the two tenants and shall be finished on both sides. Tenants are encouraged to make use of the Special Feature Zone, an area where they are allowed to construct 3d signage elements that extend past the neutral frame.

Design Condition A6 – In-Line, Split-Condition Neutral Frame

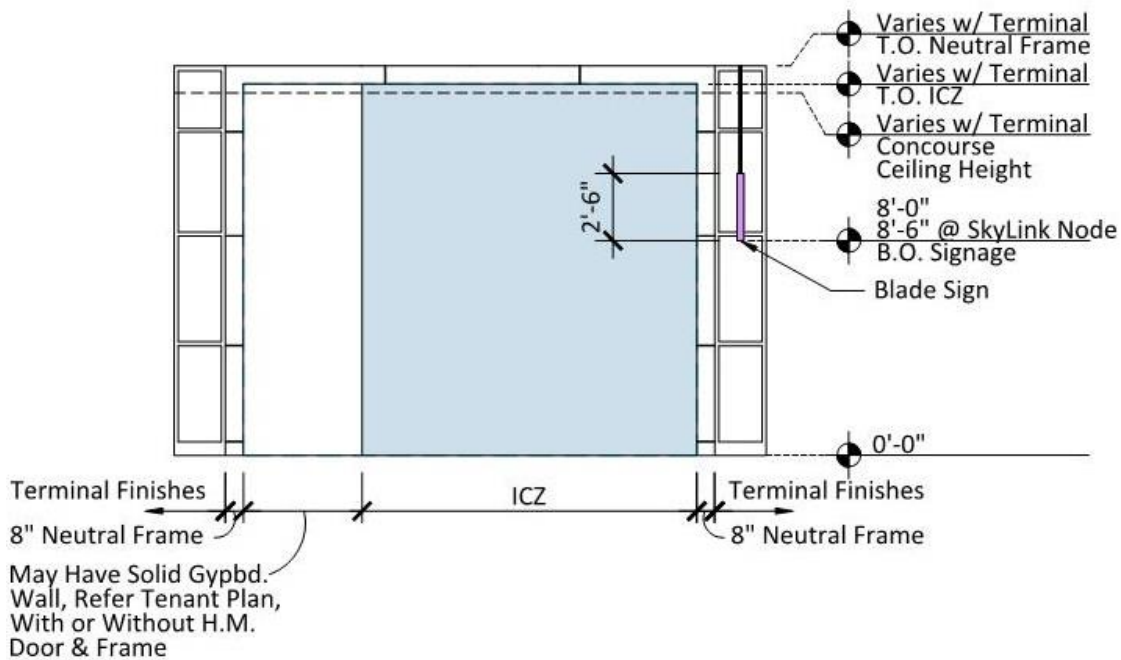

Elevation – Design Condition A6
Figure 2.38

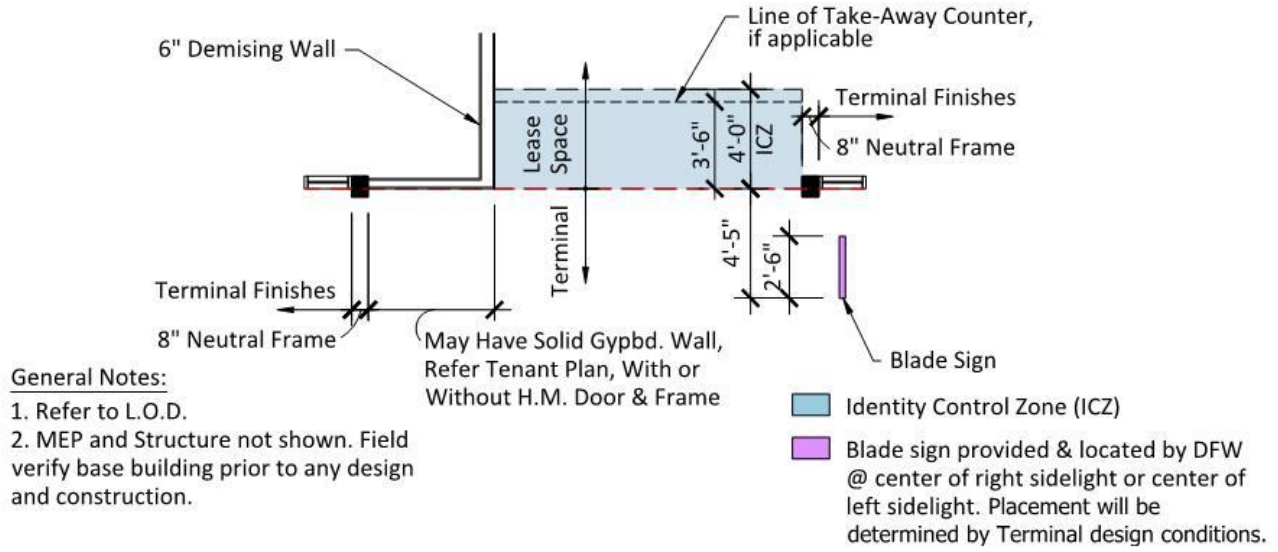

Plan – Design Condition A6
Figure 2.39

Design Condition A6 – In-Line, Split-Condition Neutral Frame

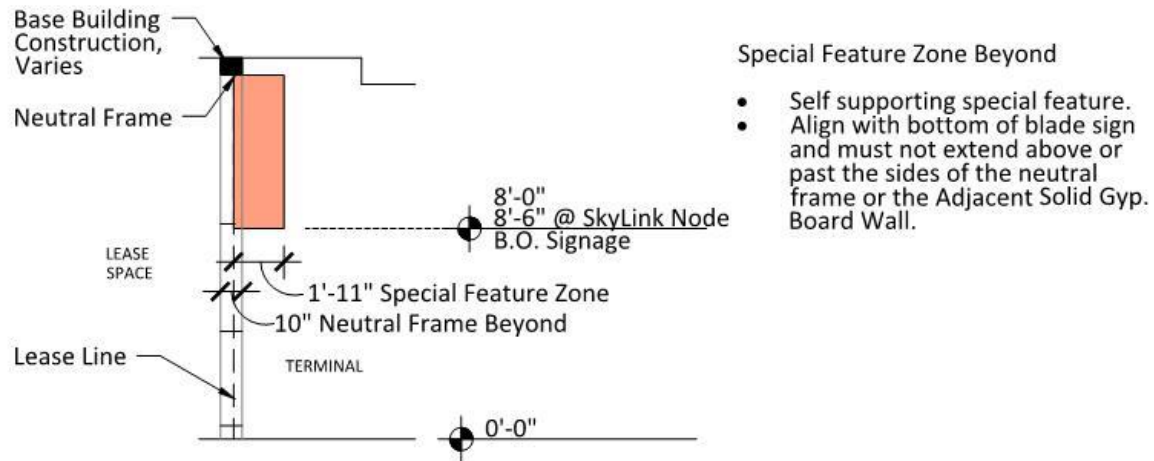

Section – Design Condition A6, Special Feature Zone
Figure 2.40

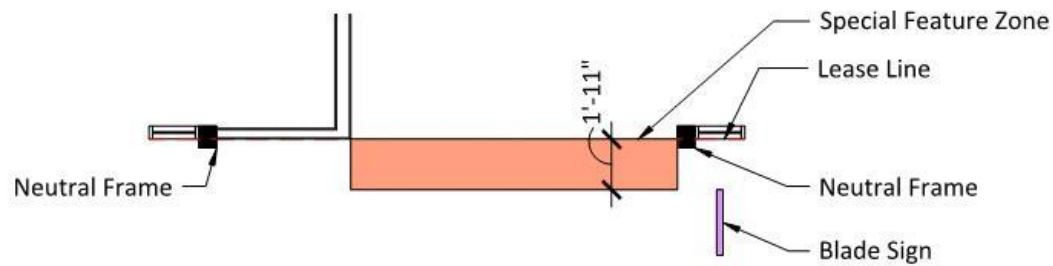

General Notes:

1. Refer to L.O.D.
2. MEP and Structure not shown. Field verify base building prior to any design and construction.

- Special Feature Zone
- Blade sign provided & located by DFW @ center of right sidelight or center of left sidelight. Placement will be determined by Terminal design conditions.

Plan – Design Condition A6, Special Feature Zone
Figure 2.41

Design Condition A6 – In-Line, Split-Condition Neutral Frame

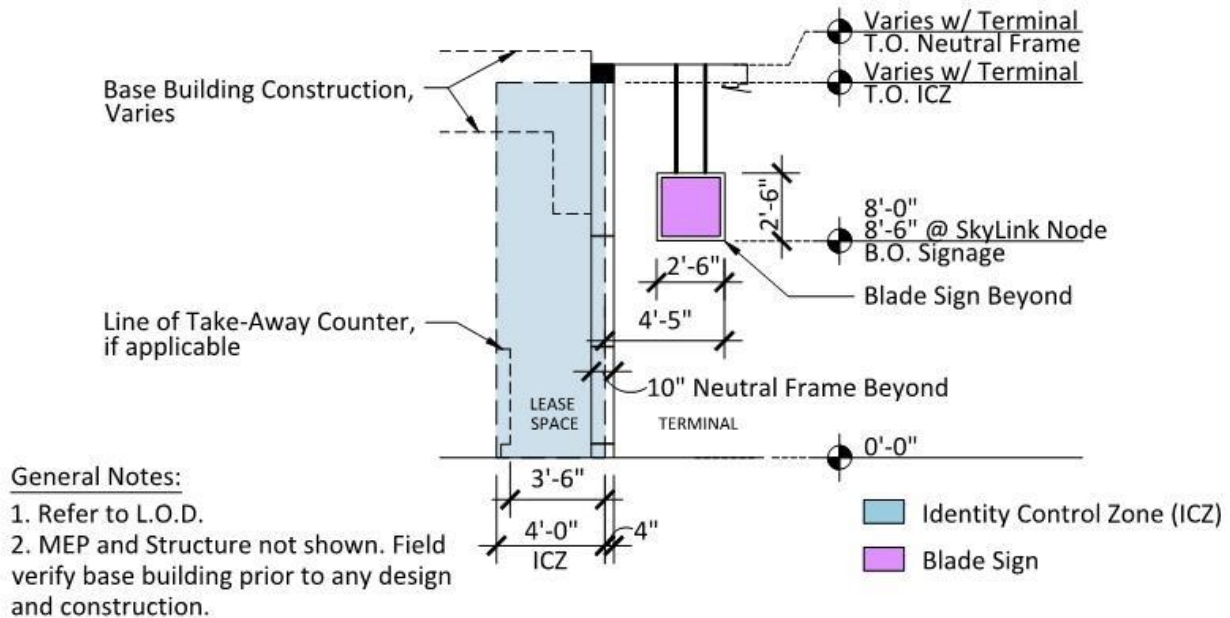

Section – Design Condition A6
Figure 2.42

For additional information:

Reference Section 3.1, "Lease Space Guidelines"

Reference Section 3.3, "Food and Beverage Tenants"

Reference Section 3.3.2, "Take-Away Counters" (if applicable)

Reference Section 3.3.3, "Grab & Go Units" (if applicable)

Reference Section 3.5, "Signage Criteria"

Reference L.O.D.'s for specific leasehold detail

2.2.2 Design Condition B – Freestanding

The freestanding design conditions are located in the SkyLink nodes and may have multiple storefront openings. They are distinguished by Identity Control Zones and where applicable, a blade sign in front of the primary opening (refer to plan and elevation diagrams related to each design condition). The SkyLink nodes were additions to the terminal, and therefore have a different structural grid than the rest of the terminal. Due to the merging of two grids, the freestanding conditions are considered “Omni-bay” conditions. They may or may not include an existing intervening column within the identity control zone. Any existing column(s) within the ICZ or within the enclosed space of the concession must be finished. Tenants should refer to the L.O.D. for other columns within the open seating or display areas which need to be finished out. The tenant should approach the column finishes as an opportunity for a holistic design.



2.2.2.1 Design Condition B1 – Freestanding, Omni-Bay with Neutral Frame

The freestanding design condition B1 is located in the SkyLink node with various ceiling heights and cove conditions in front of the storefront. Tenants are encouraged to make use of the Special Feature Zone, an area where they are allowed to construct 3d signage elements that extend past the neutral frame.

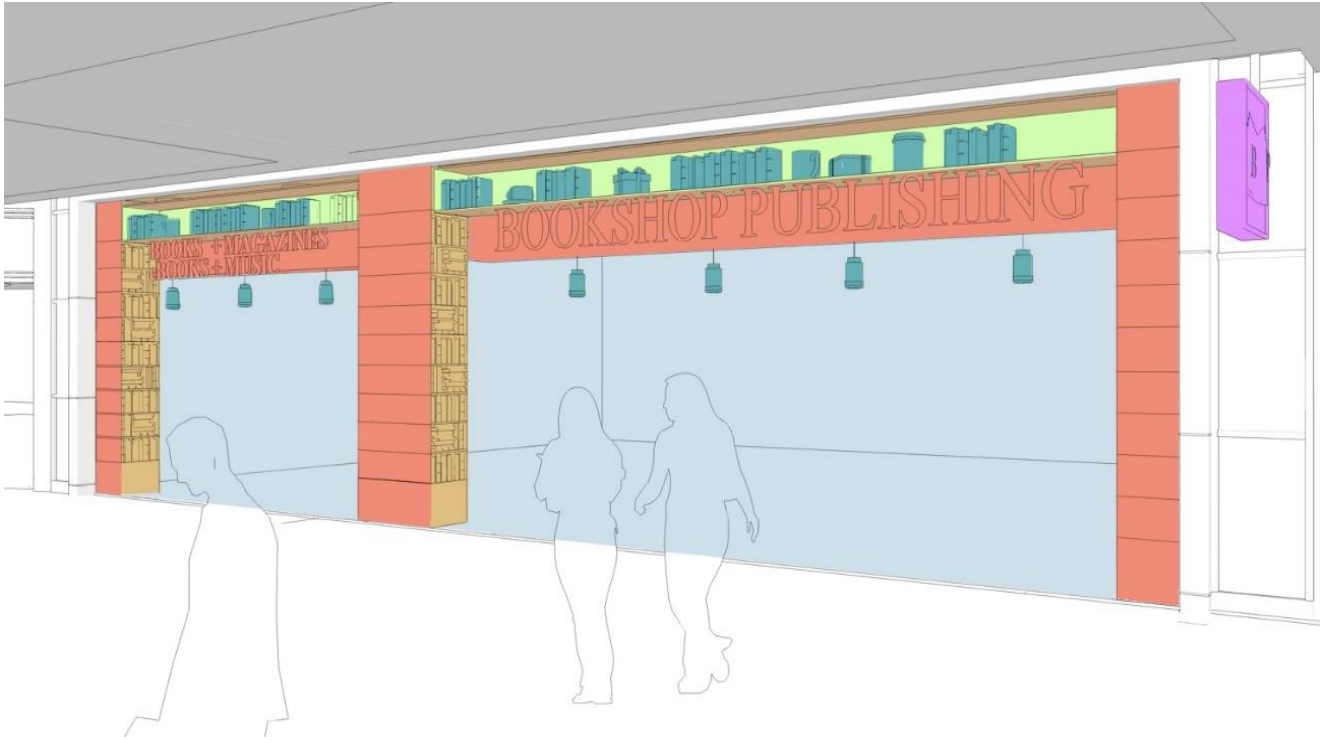

Required:

Identity Control Zone Blade Signage

Elements in Identity Control Zone may or may not include:

Feature Wall	Soffit	Counter
Jamb Feature	Canopy	3-d object
Display Case		

Diagram of Design Condition B1
Figure 2.44

Design Condition B1 – Freestanding, Omni-Bay with Neutral Frame

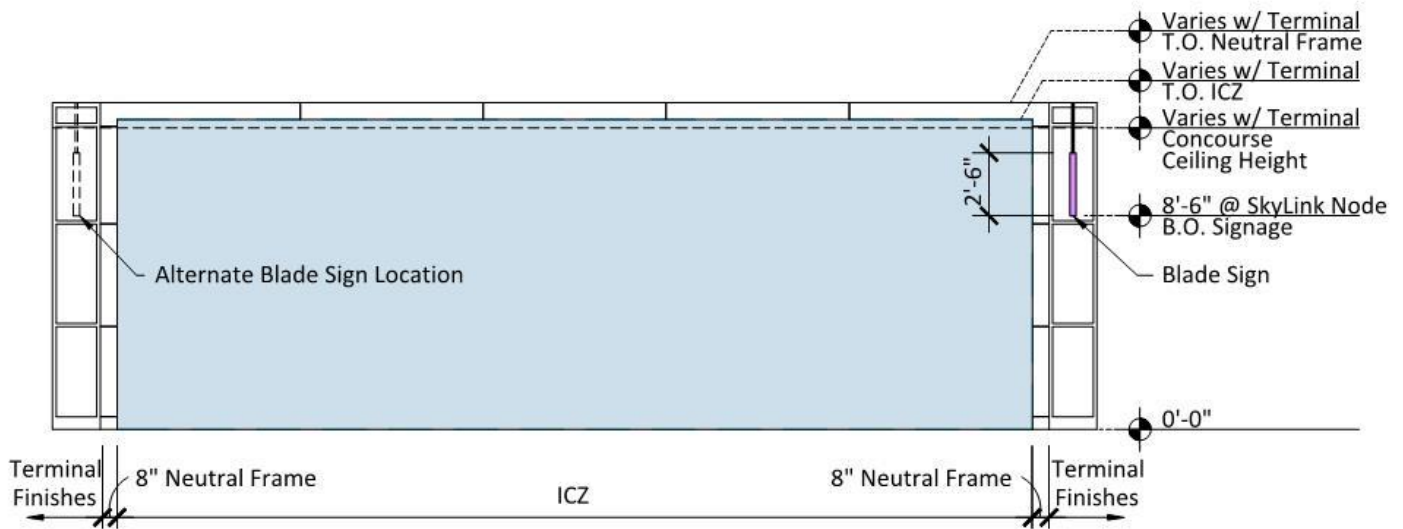

Elevation – Design Condition B1
 Figure 2.45

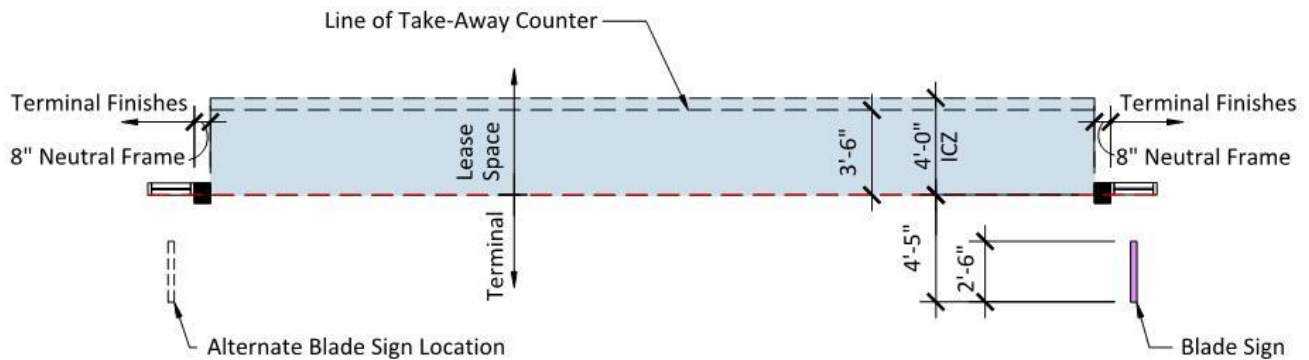

General Notes:

1. Refer to L.O.D.
2. MEP and Structure not shown. Field verify base building prior to any design and construction.

- Identity Control Zone (ICZ)
- Blade sign provided & located by DFW @ center of right sidelight or center of left sidelight. Placement will be determined by Terminal design conditions.

Plan – Design Condition B1
 Figure 2.46

Design Condition B1 – Freestanding, Omni-Bay with Neutral Frame

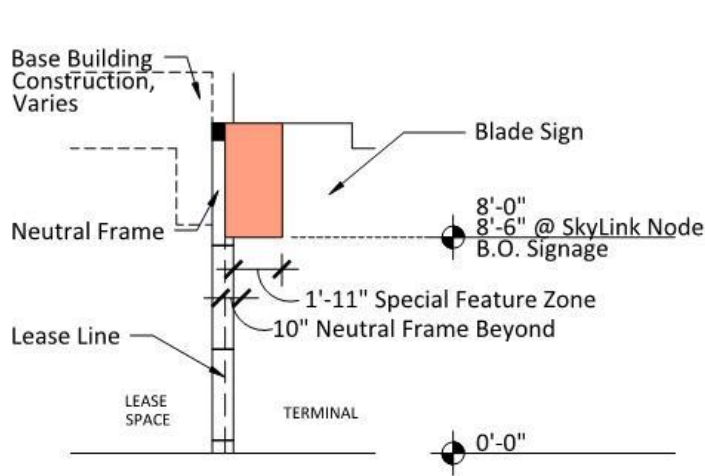

Special Feature Zone Beyond

- Self supporting special feature.
- Align with bottom of blade sign and must not extend above or past the sides of the neutral frame.

Section – Design Condition B1, Special Feature Zone
Figure 2.47

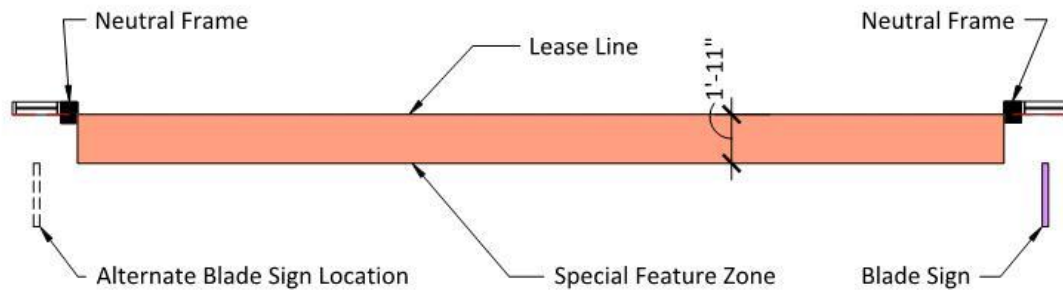

General Notes:

1. Refer to L.O.D.
2. MEP and Structure not shown. Field verify base building prior to any design and construction.

- Special Feature Zone
- Blade sign provided & located by DFW @ center of right sidelight or center of left sidelight. Placement will be determined by Terminal design conditions.

Plan – Design Condition B1, Special Feature Zone
Figure 2.48

Design Condition B1 – Freestanding, Omni-Bay with Neutral Frame

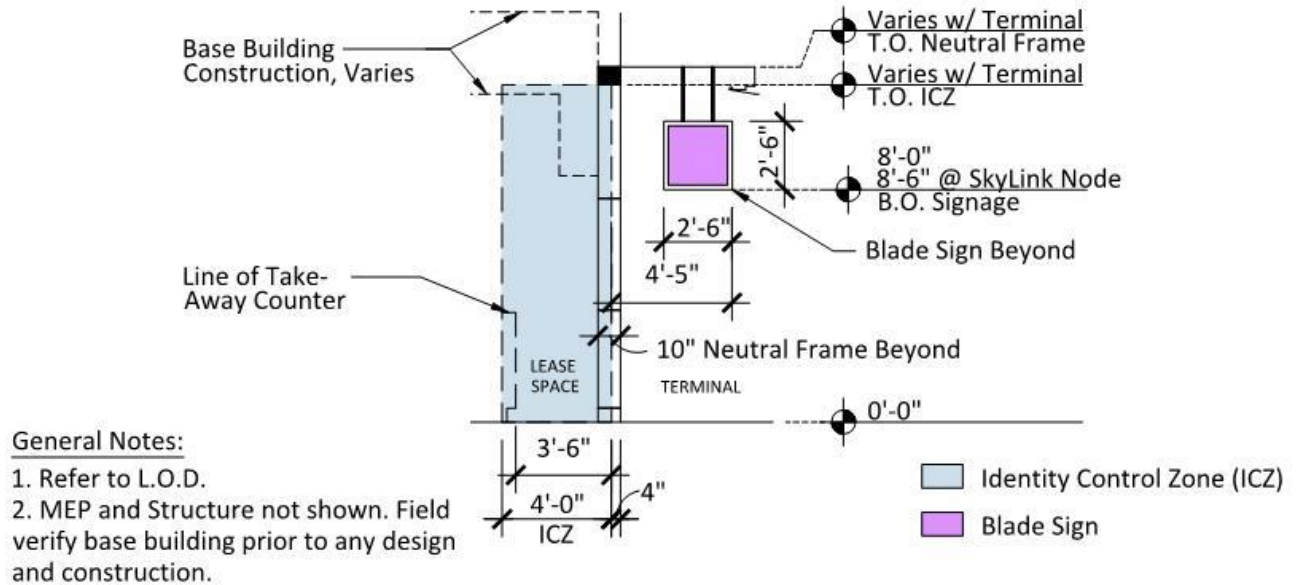

Section – Design Condition B1
Figure 2.49

For additional information:

Reference Section 3.1, "Lease Space Guidelines"

Reference Section 3.3, "Food and Beverage Tenants"

Reference Section 3.3.2, "Take-Away Counters" (if applicable)

Reference Section 3.3.3, "Grab & Go Units" (if applicable)

Reference Section 3.5, "Signage Criteria"

Reference L.O.D.'s for specific leasehold details

2.2.2.2 Design Condition B2 – Freestanding, Omni-Bay, Shared Seating Area and Common Railing

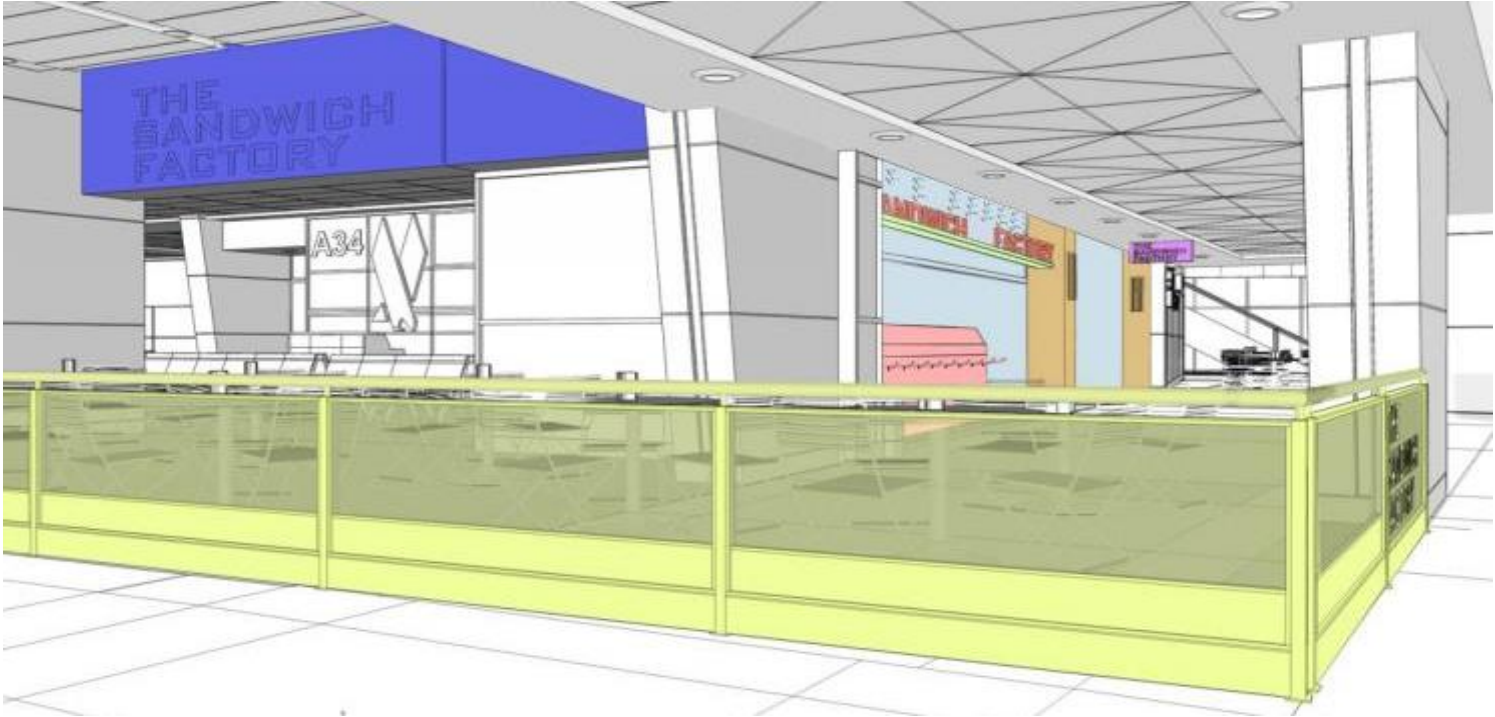









Diagram of Design Condition B2
Figure 2.50

Required:

- | | | |
|--|---|--|
|  Identity Control Zone |  Blade Signage |  Bulkhead Signage |
|  Railing (refer to LOD) | | |

Elements in Identity Control Zone, may or may not include:

- | | | |
|--|--|--|
|  Feature Wall |  Soffit |  Counter |
|  Jamb Feature |  Canopy |  3-d object |
|  Display Case | | |

The freestanding design condition B2 is located in all SkyLink nodes alongside the SkyLink "wedge" and has no neutral frame. Signage space for these leaseholds is available on the bulkhead facing the concourse walkway.

Railing must be provided by tenant if they intend to serve alcohol.

- DFW will provide the ceiling finishes under the "wedge"
- DFW will provide the ceiling finishes from the structural "E" line to concourse corridor
- Concessionaire to provide ceiling finishes in all other areas within the lease boundary
- Blade sign to be coordinated between tenants and DFW.

(Refer to Section 3.1.3, "Flooring Materials and Transition" for existing terrazzo floor requirements.)

For additional information:

Reference Section 3.1, "Lease Space Guidelines"

Reference Section 3.3, "Food and Beverage Tenants"

Reference Section 3.3.2, "Take-Away Counters" (if applicable)

Reference Section 3.3.3, "Grab & Go Units" (if applicable)

Reference Section 3.4.1, "Railings"

Reference Section 3.5, "Signage Criteria"

Reference L.O.D.'s for specific leasehold details

2.2.2.3 Design Condition B3 – Freestanding, with No Neutral Frame, shared seating area and common railing:

Design Condition B3 is located in the Skylink nodes near the entrance to the SkyLink Station and has no neutral frame. The tenants share bulkhead signage facing the concourse as well as perimeter railing. Design of shared signage area must be mutually agreed upon between the tenants and approved by DFW Concessions. Costs for bulkhead signage will be shared between the concessionaires.

Railing must be provided by individual tenants if both intend to serve alcohol. Costs for railing will be shared between the concessionaires.

- DFW will provide the ceiling finishes under the "wedge"
- DFW will provide the ceiling finishes from the structural "E" line to concourse corridor
- Concessionaire to provide ceiling finishes in all other areas within the lease boundary
- Blade sign to be coordinated between tenants and DFW.

For additional information:

Reference Section 3.1, "Lease Space Guidelines"

Reference Section 3.3, "Food and Beverage Tenants"

Reference Section 3.3.2, "Take-Away Counters" (if applicable)

Reference Section 3.3.3, "Grab & Go Units" (if applicable)

Reference Section 3.4., "Railings"

Reference Section 3.5, "Signage Criteria"

Reference L.O.D.'s for specific leasehold details

2.2.2.4 Design Condition B4 – Freestanding, No Neutral Frame

The skylight at the south SkyLink node of Terminal A presents a distinctive opportunity for this design condition. No neutral frame is provided, therefore, design is less restrained. However, DFW Concessions approval is required. Line of sight from concourse to airline ticket counter must be unobstructed. Full height design elements located within the seating area must be approved by DFW Concessions and American Airlines.

Railing and signage are provided by the tenant. Blade sign to be coordinated between tenants and DFW.

(Refer to Section 3.1.3, "Flooring Materials and Transition" for existing terrazzo floor requirements.)

For additional information:

Reference Section 3.1, "Lease Space Guidelines"

Reference Section 3.3, "Food and Beverage Tenants"

Reference Section 3.3.3, "Grab & Go Units" (if applicable)

Reference Section 3.4, "Railings"

Reference Section 3.5, "Signage Criteria"

Reference L.O.D.'s for specific leasehold details

2.2.2.5 Design Condition B5 – Freestanding, with No Neutral Frame, Facing the B Stinger Concourse

The freestanding design condition B5 is located along the B stringer concourse in the Terminal B North SkyLink area. The front portion of the concession is under a low "wedge" ceiling condition and is to be an unwallied seating/display area enclosed by a railing. Side branding along the holdroom wall is not allowed. Storefront designs must not protrude past the main lease area into the seating/display area.

DFW will provide the ceiling finishes under the "wedge". The Concessionaire is to provide ceiling finishes in all other areas within the lease boundary. The blade sign will be located in the concourse walkway leading to the B Stinger and will be centered on the Concessionaire's storefront.

The design for the shared railing between the front portions of adjoining spaces needs to be agreed upon and paid for by both parties. Railings and signage along the Stinger concourse are provided by the tenant and must be approved by DFW Concessions.

This design condition, as with all design conditions, must comply with applicable codes, standards and airport requirements.

For additional information:

Reference Section 3.1, "Lease Space Guidelines"

Reference Section 3.3, "Food and Beverage Tenants"

Reference Section 3.3.2, "Take-Away Counters" (if applicable)

Reference Section 3.3.3, "Grab & Go Units" (if applicable)

Reference Section 3.4, "Railings"

Reference Section 3.5, "Signage Criteria"

Reference L.O.D.'s for specific leasehold details

2.2.3 Design Condition C – Corner

Corner design conditions have two in-line storefronts. The front storefront faces the public circulation path. Architectural conditions of the terminal will vary depending on the location of leasehold. A maximum of one blade sign is allowed per tenant. Refer to design condition diagrams for which neutral frame, if any, allows for blade signage.



Example of Design Condition C1
Figure 2.57

2.2.3.1 Design Condition C1 – Corner Condition with Neutral Frames

This design condition has two in-line storefronts. The front neutral frame is along the main concourse walkway, similar to Design Condition A1, but the secondary storefront has a neutral frame facing the exit path to landside. A blade sign is allowed along the main concourse walkway. Tenants are encouraged to make use of the Special Feature Zone, an area where they are allowed to construct 3d signage elements that extend past the neutral frame.

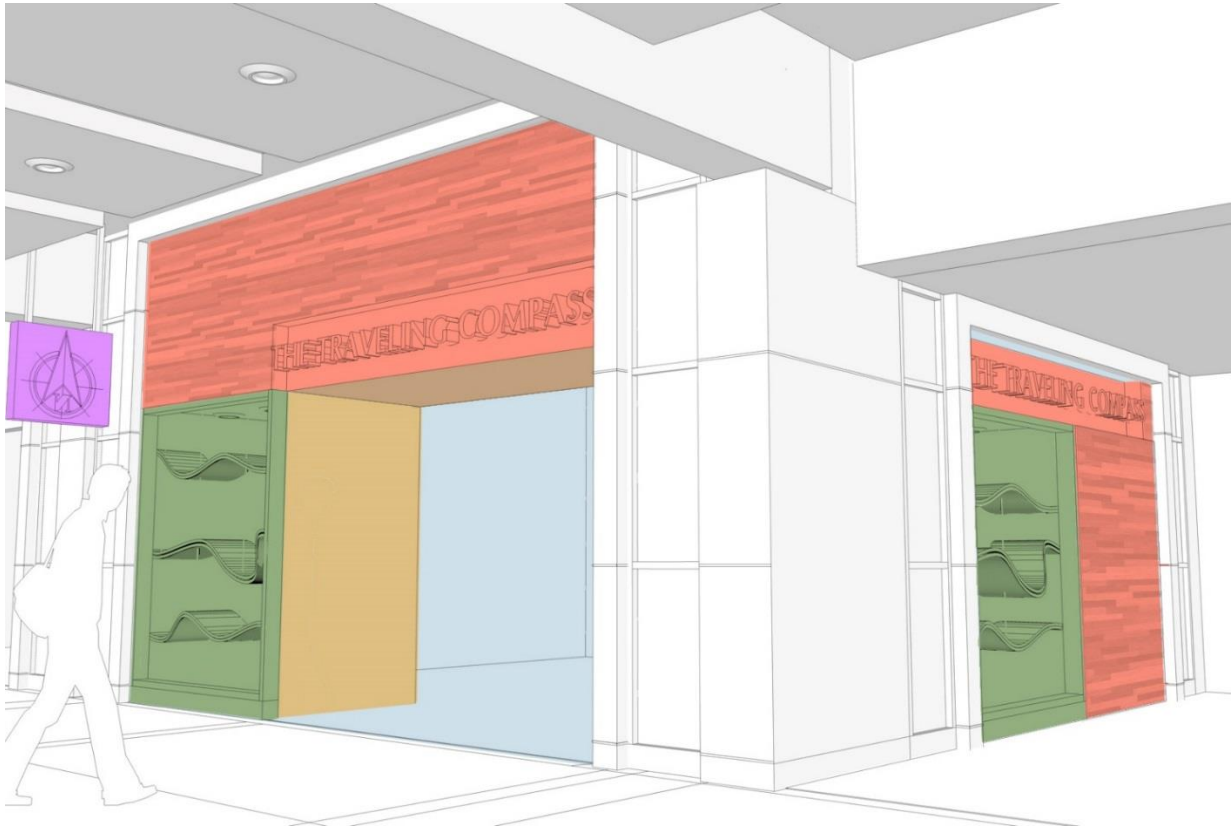

Required:

- Identity Control Zone
- Blade Signage

Elements in Identity Control Zone may or may not include:

- Feature Wall
- Soffit
- Counter
- Jamb Feature
- Canopy
- 3-d object
- Display Case

Diagram of Design Condition C1
Figure 2.58

Design Condition C1 – Corner Condition Neutral Frame – Side 1

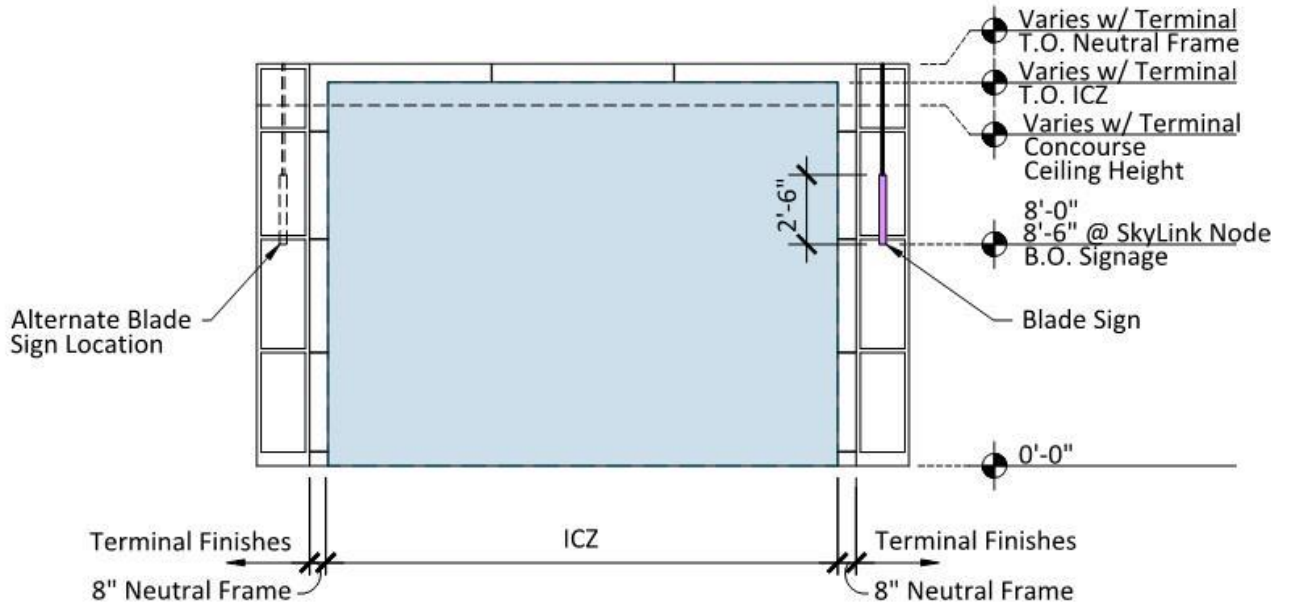

Elevation – Design Condition C1 – Side 1
Figure 2.59

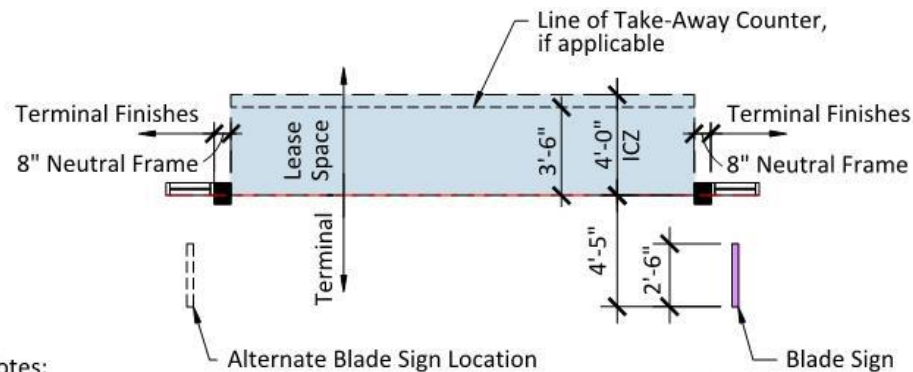

General Notes:

1. Refer to L.O.D.
2. MEP and Structure not shown. Field verify base building prior to any design and construction.

Plan – Design Condition C1 – Side 1
Figure 2.60

Design Condition C1 – Corner Condition Neutral Frame – Side 1

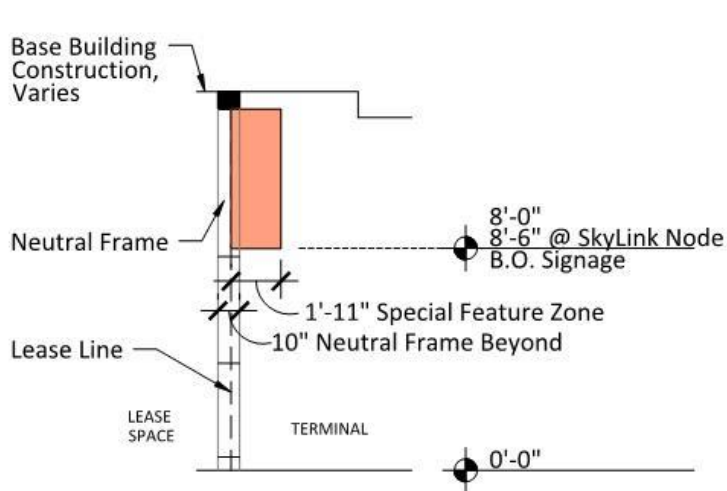

Special Feature Zone Beyond

- Self supporting special feature.
- Align with bottom of blade sign and must not extend above or past the sides of the neutral frame.

Section – Design Condition C1 – Side 1, Special Feature Zone
Figure 2.61

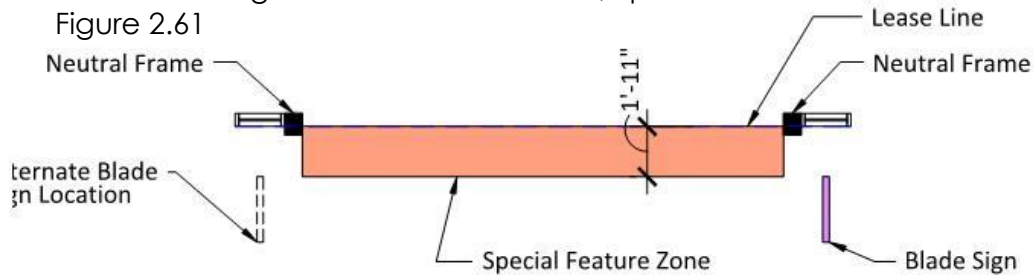

General Notes:

1. Refer to L.O.D.
2. MEP and Structure not shown. Field verify base building prior to any design and construction.

- Special Feature Zone
- Blade sign provided & located by DFW @ center of right sidelight or center of left sidelight. Placement will be determined by Terminal design conditions.

Plan – Design Condition C1 – Side 1, Special Feature Zone
Figure 2.62

Design Condition C1 – Corner Condition Neutral Frame – Side 1

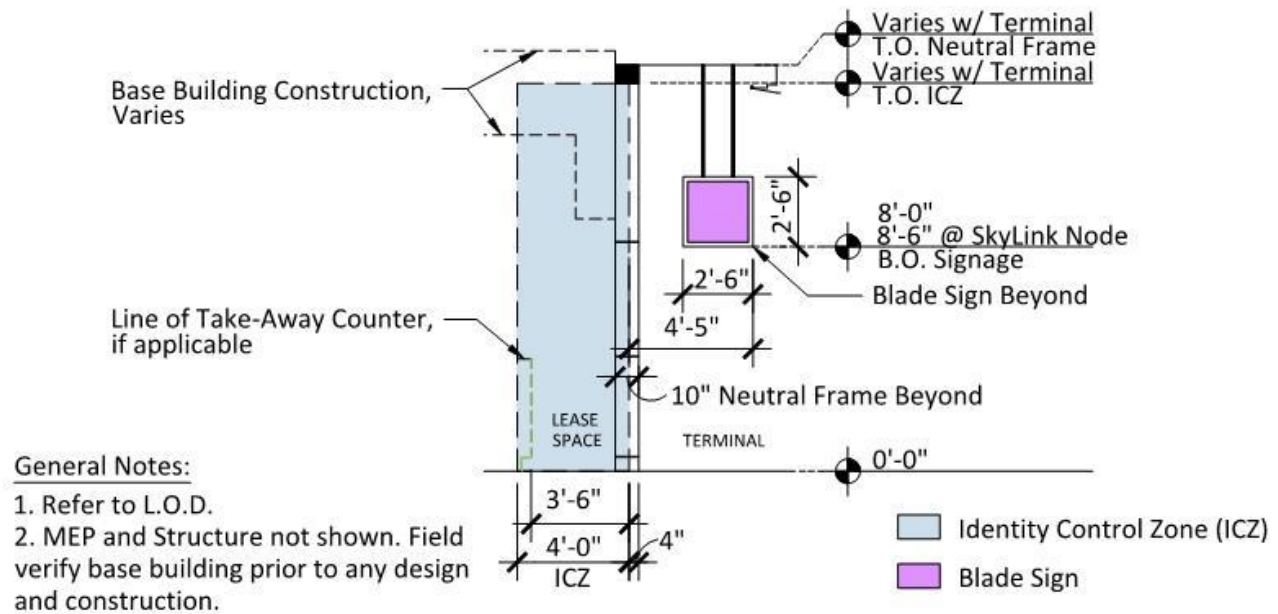

Section – Design Condition C1 – Side 1
Figure 2.63

For additional information:

Reference Section 3.1, "Lease Space Guidelines"

Reference Section 3.3, "Food and Beverage Tenants"

Reference Section 3.3.2, "Take-Away Counters" (if applicable)

Reference Section 3.3.3, "Grab & Go Units" (if applicable)

Reference Section 3.5, "Signage Criteria"

Reference L.O.D.'s for specific leasehold details

Design Condition C1 – Corner Condition with Neutral Frame – Side 2

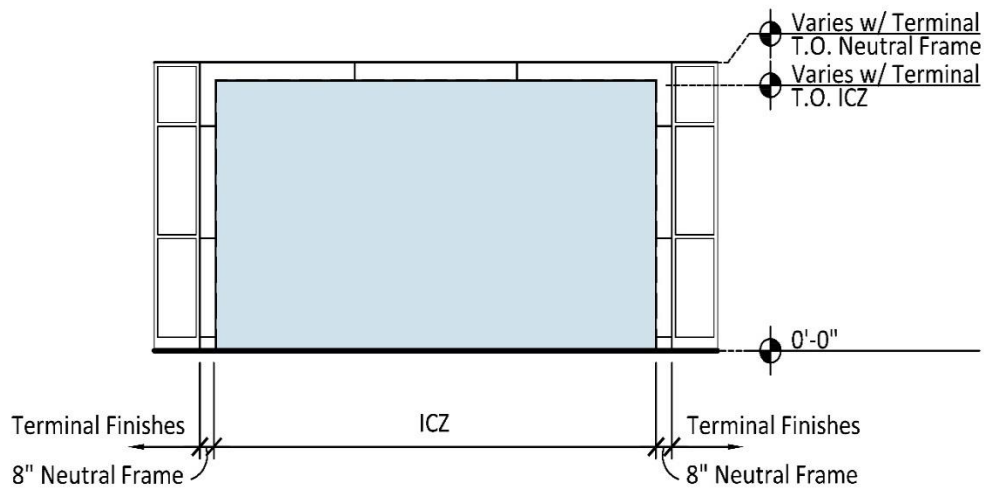

Elevation – Design Condition C1 – Side 2
Figure 2.64

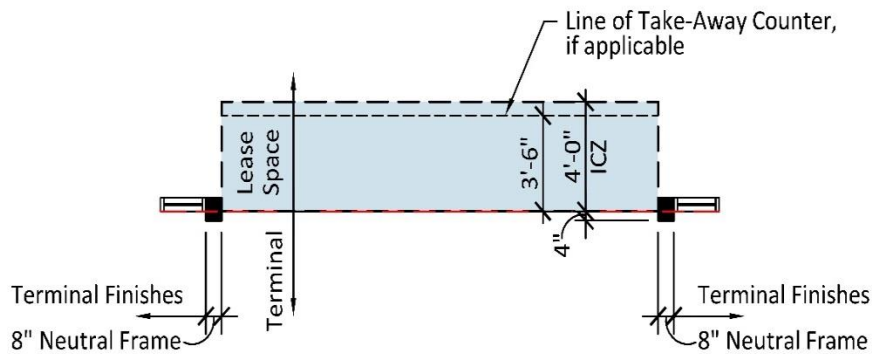

General Notes:

1. Refer to L.O.D.
2. MEP and Structure not shown. Field verify base building prior to any design and construction.

Identity Control Zone (ICZ)

Plan – Design Condition C1 – Side 2
Figure 2.65

Design Condition C1 – Corner Condition with Neutral Frame – Side 2

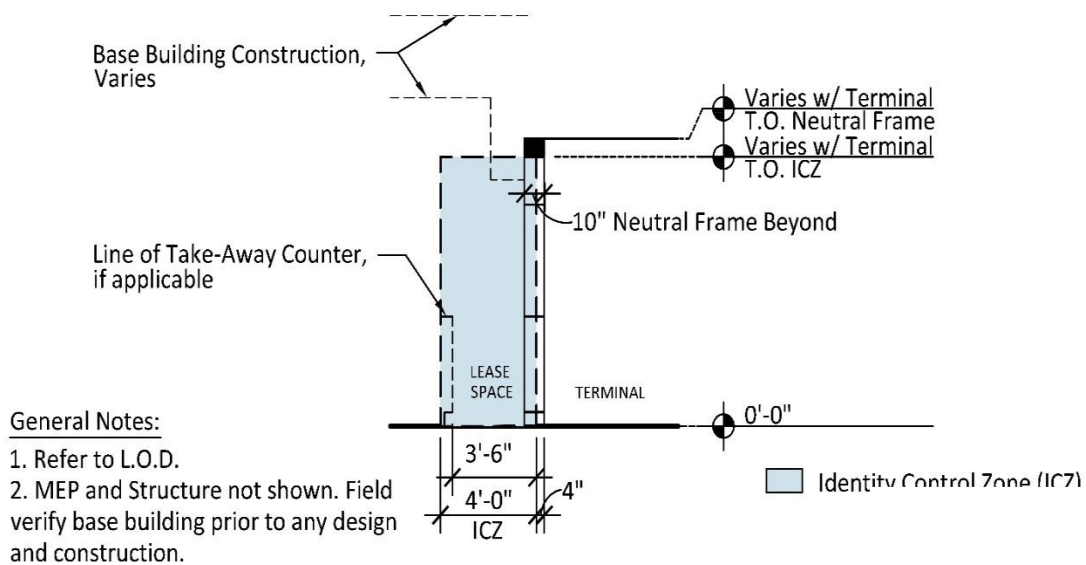

Section – Design Condition C1 – Side 2
Figure 2.66

For additional information:

Reference Section 3.1, "Lease Space Guidelines"

Reference Section 3.3, "Food and Beverage Tenants"

Reference Section 3.3.2, "Take-Away Counters" (if applicable)

Reference Section 3.3.3, "Grab & Go Units" (if applicable)

Reference Section 3.5, "Signage Criteria"

Reference L.O.D.'s for specific leasehold details

2.2.3.2 Design Condition C2 – Corner with 8’-2” and 11’-6” Neutral Frames

The C2 design conditions are located along the landside corridor with two storefronts. One neutral frame is located on the landside and is low due to the lower ceiling on the landside corridor. The second storefront has a higher neutral frame facing the bag claim area. Blade signs will not be provided in these locations.



Required:

Identity Control Zone

Elements in Identity Control Zone may or may not include:

Feature Wall

Soffit

Counter

Jamb Feature

Canopy

3-d object

Display Case

Diagram of Design Condition C2
Figure 2.67

Design Condition C2 – Corner with low Neutral Frame – Side 1

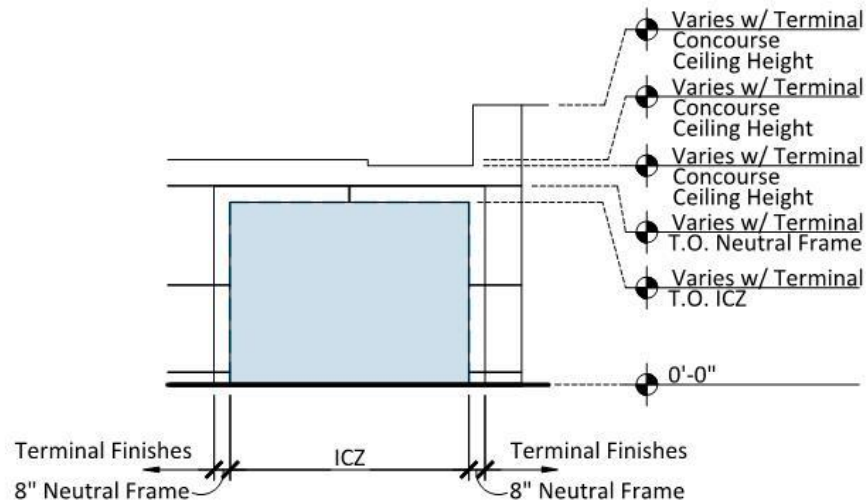

Elevation – Design Condition C2 – Side 1
Figure 2.68

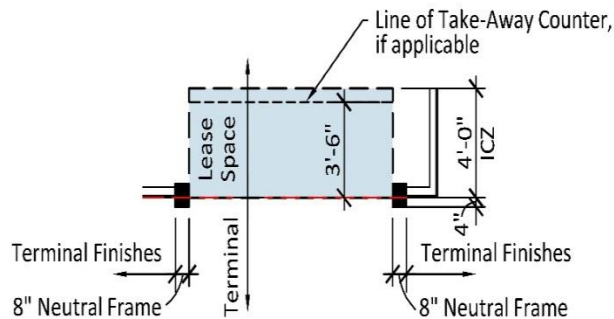

General Notes:

1. Refer to L.O.D.
2. MEP and Structure not shown. Field verify base building prior to any design and construction.

Identity Control Zone (ICZ)

Plan – Design Condition C2 – Side 1
Figure 2.69

Design Condition C2 – Corner with low Neutral Frame – Side 1

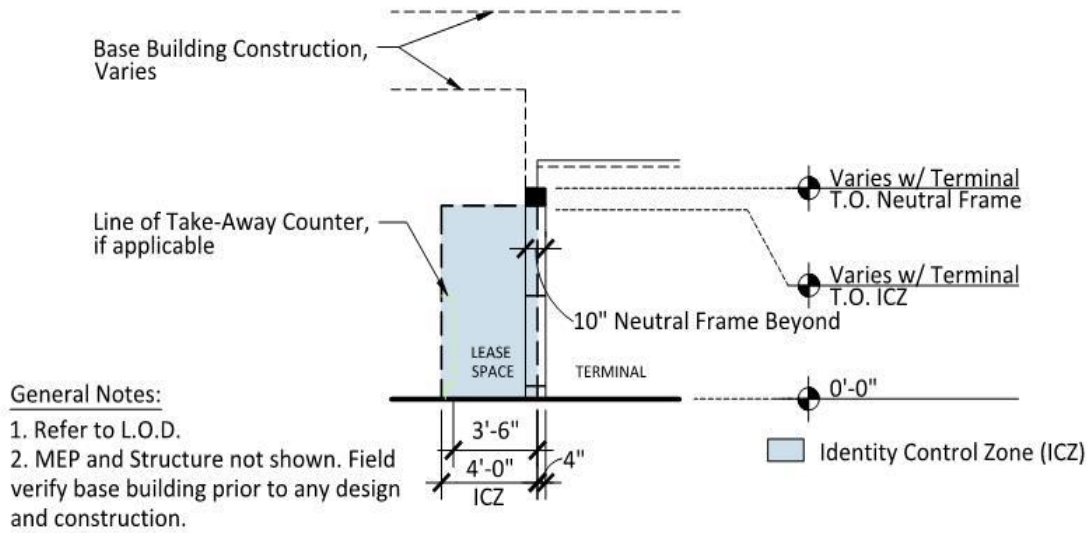

Section – Design Condition C2 – Side 1
 Figure 2.70

Design Condition C2 – Corner with high Neutral Frame – Side 2

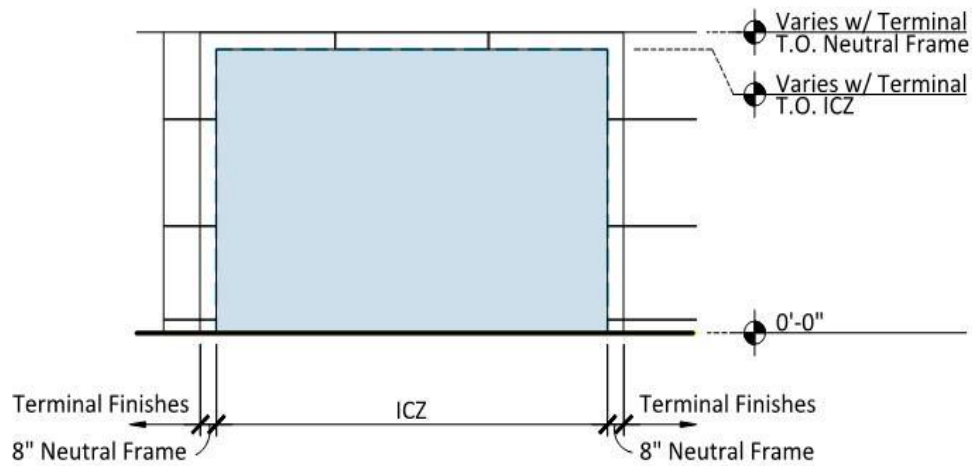

Elevation – Design Condition C2 – Side 2
Figure 2.71

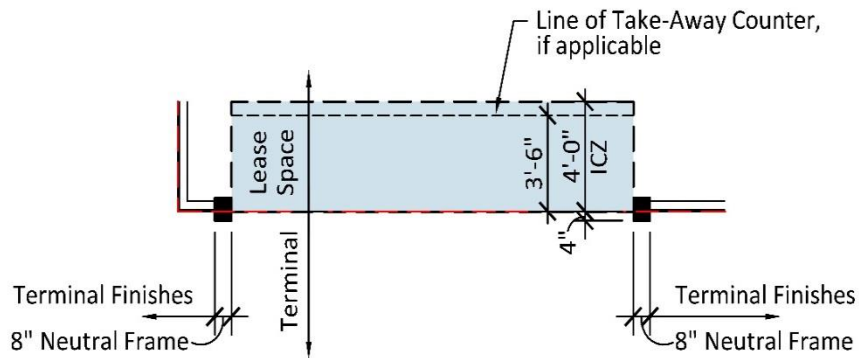

General Notes:

1. Refer to L.O.D.
2. MEP and Structure not shown. Field verify base building prior to any design and construction.

 Identity Control Zone (ICZ)

Plan – Design Condition C2 – Side 2
Figure 2.72

Design Condition C2 – Corner with high Neutral Frame – Side 2

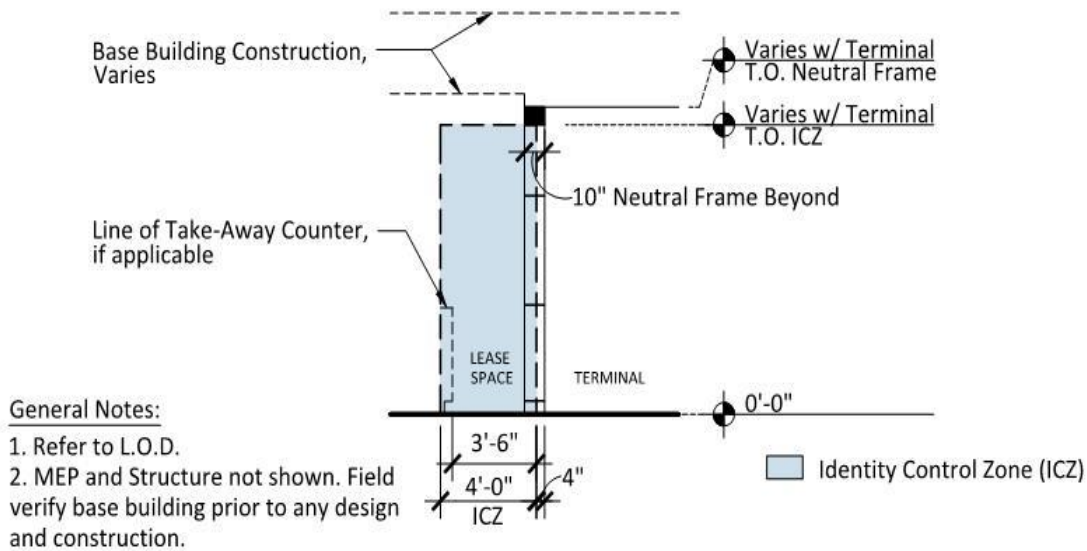

Section – Design Condition C2 – Side 2
 Figure 2.73

For additional information:

Reference Section 3.1, "Lease Space Guidelines"

Reference Section 3.3, "Food and Beverage Tenants"

Reference Section 3.3.2, "Take-Away Counters" (if applicable)

Reference Section 3.3.3, "Grab & Go Units" (if applicable)

Reference Section 3.5, "Signage Criteria"

Reference L.O.D.'s for specific leasehold details

2.2.3.3 Design Condition C3 – Corner with 9’ Neutral Frame on Both Sides

Located near the baggage claim area, non-boarding passengers have access to the C3 Condition leaseholds. Both storefront sides have 9’ neutral frames. Blade signs will not be provided in these locations.



Required:

Identity Control Zone

Elements in Identity Control Zone may or may not include:

Feature Wall

Soffit

Counter

Jamb Feature

Canopy

3-d object

Display Case

Diagram of Design Condition C3
Figure 2.74

Design Condition C3 – Corner with 9' Neutral Frames on Both Sides

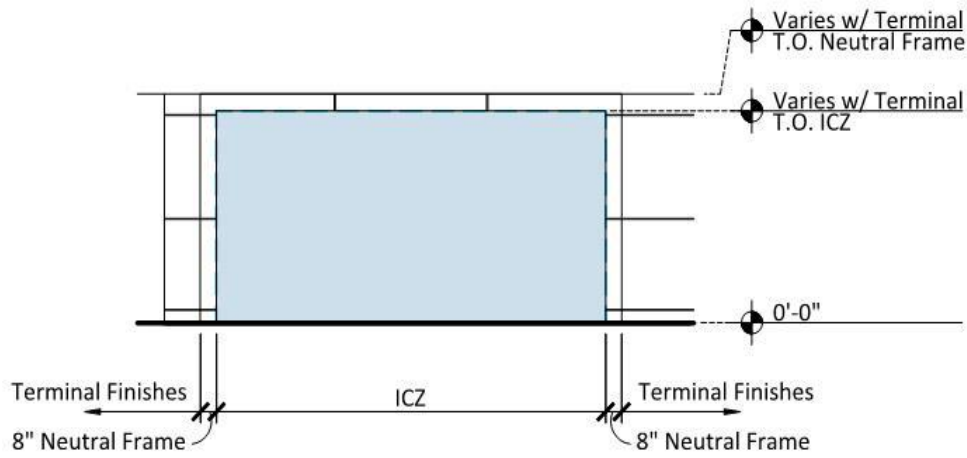

Elevation – Design Condition C3
Figure 2.75

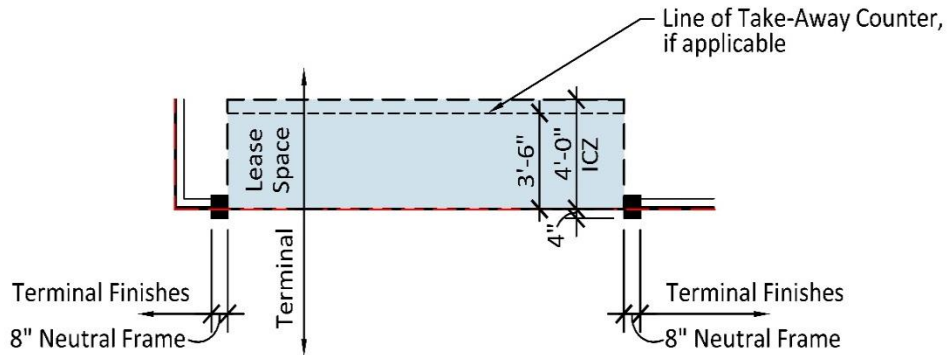

General Notes:

1. Refer to L.O.D.
2. MEP and Structure not shown. Field verify base building prior to any design and construction.

 Identity Control Zone (ICZ)

Plan – Design Condition C3
Figure 2.76

Design Condition C3 – Corner with 9' Neutral Frames on Both Sides

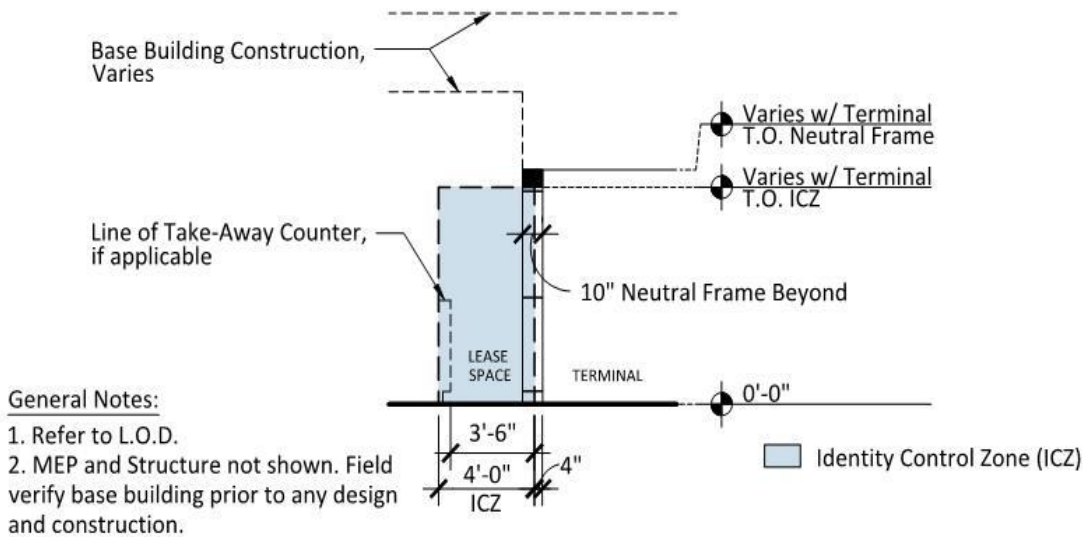

Section – Design Condition C3
 Figure 2.77

For additional information:

Reference Section 3.1, "Lease Space Guidelines"

Reference Section 3.3, "Food and Beverage Tenants"

Reference Section 3.3.2, "Take-Away Counters" (if applicable)

Reference Section 3.3.3, "Grab & Go Units" (if applicable)

Reference Section 3.5, "Signage Criteria"

Reference L.O.D.'s for specific leasehold details

3.0 DESIGN CRITERIA

3.1 Lease Space Guidelines

3.1.1 Storefront

The storefront consists of the neutral frame and store enclosure. An Identity Control Zone has been established as a transition between the concourse and the tenant store interior.

3.1.1.1 Neutral Frame

The Neutral Frame is a metal frame at the storefront openings that provides the demarcation between tenant and base building finishes. The Airport provides the Neutral Frame. The tenant is responsible for providing a 3/4" black reveal between the Neutral Frame and the tenant improvement store enclosure. No reveal is required when using frameless (butt joint) glazing against the neutral frame.

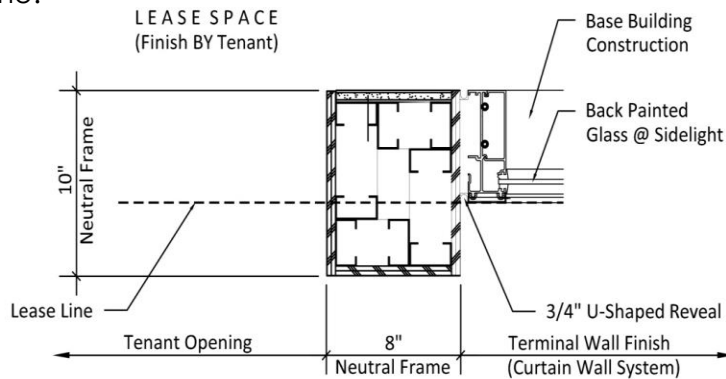

Plan Detail
Figure 3.01

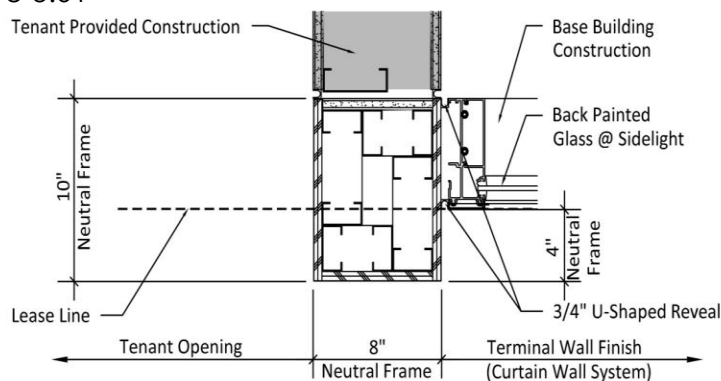

Plan Detail
Figure 3.02

Plan Detail
Figure 3.03

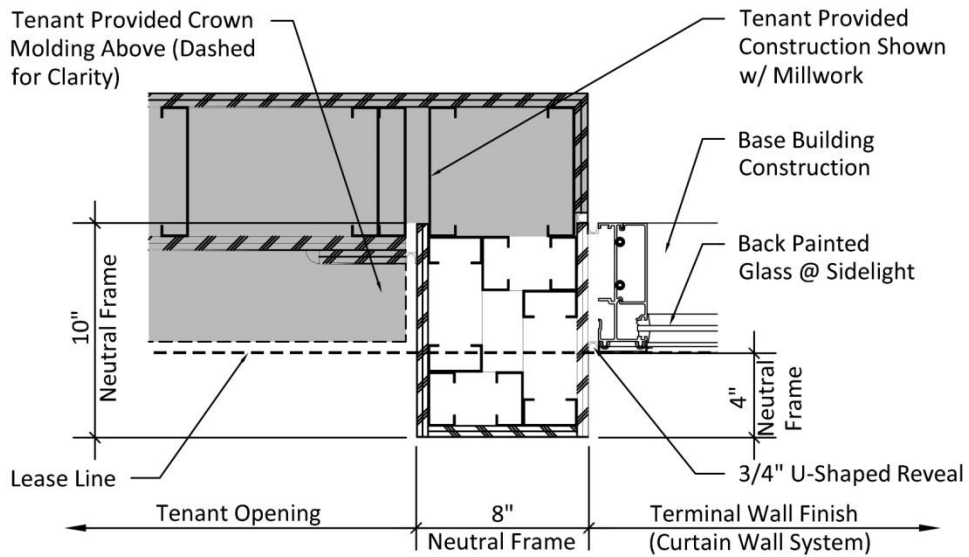
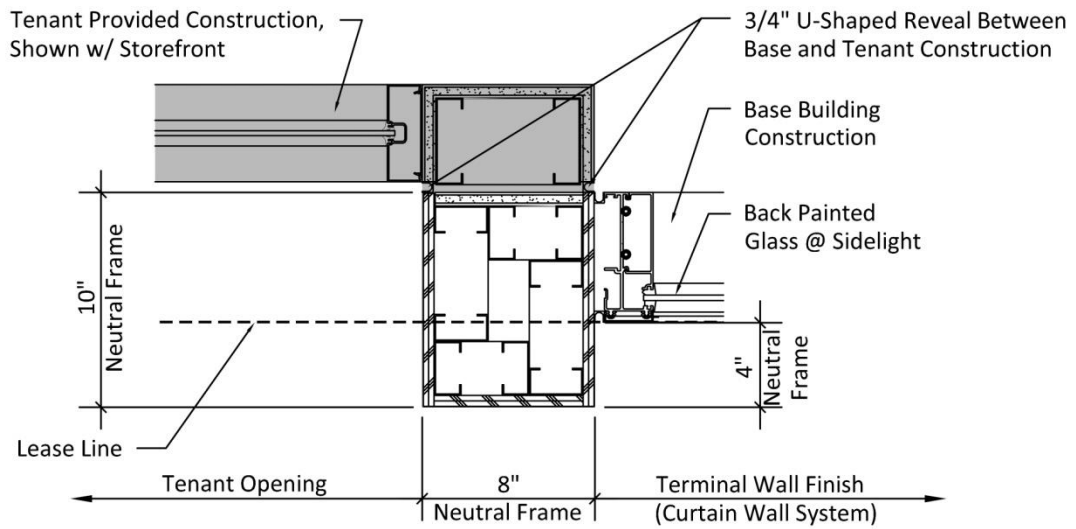

Plan Detail
Figure 3.04

3.1.1.2 Storefront Materials

Use of the following materials on the storefront and within the Identity Control Zone is strictly prohibited:

1. Engineered/simulated versions of any material such as brick, stone, or wood.
2. Plastic laminates. High impact plastic laminate with edge treatment may be considered by DFW Concessions.
3. Pegboard, slat board walls, or fixture systems.
4. Vinyl wall covering, fabric, or wallpaper. Decorative murals may be allowed pending DFW Concessions approval, but if allowed they will need to be protected.
5. Large areas of plain, smooth, painted gypsum board.
6. Simulated paneling; pre-finished or scored plywood products and diagonal wood siding.
7. Rough sawn, re-used or recycled lumber.
8. Lapped siding composed of wood, vinyl or aluminum.
9. Highly textured paint or stucco.
10. Shingles, cork or wall mounted carpet.
11. Masonry with highly textured surfaces or sharp corners.
12. Rough sawn cedar or other unfinished woods.

All storefronts, excluding doors, must have a 6" minimum base of durable material such as granite, marble, stone, terrazzo, brass, stainless steel, or other durable material adhered to a solid backing. Vinyl, rubber, or wood bases are not allowed.

3.1.1.3 Openness/Transparency

Structural conditions vary throughout the terminals. Many design conditions contain existing building structural elements within the Identity Control Zone. Tenants are required to maintain a minimum 60% transparency (either open or clear glazing) below any structure located within the Identity Control Zone. This percentage applies to each side of a lease space for tenants at a corner condition.

3.1.1.4 Store Entrances

Desirable treatments for storefronts are butt joint glazing or multi-pane clear, beveled, etched or sandblasted glass in metal or hardwood framing. Recesses, angles and other devices designed to break up the length of the flat storefront are acceptable. All interior storefront glass is to meet the openness/transparency requirements of this manual (section 3.1.1.3). All storefront designs are subject to DFW Concessions approval.

All storefronts must be self-supporting. Storefronts must be buffered from the Neutral Frame and base building by a black 3/4" reveal (section 3.1.1.1, Neutral Frame), and cannot suspend from it or be braced by it. The storefront may be braced by the existing base building structure. Bracing to DFW columns and beams may be allowed, however, no penetrations are allowed in DFW concrete. Structural connection must be developed by a licensed structural engineer and is subject to approval by DFW Concessions.

For fire department admittance, doors and panel systems must be keyed for access from the concourse and be furnished with cores and keys matching the Airport's master key system. Keys are to be tagged with tenant name and a space identifier/lease space reference number provided by DFW Concessions. **(Reference Section 3.1.7, "Security")**

The following types of store entrances are permitted:

- Sliding glass doors: Size of sliding glass door panels must be coordinated with sidelights. Glass doors should not protrude into space when in the open position.
- Hinged doors: Swinging doors must be fully recessed, out-swinging, and must not extend/swing beyond the lease line.

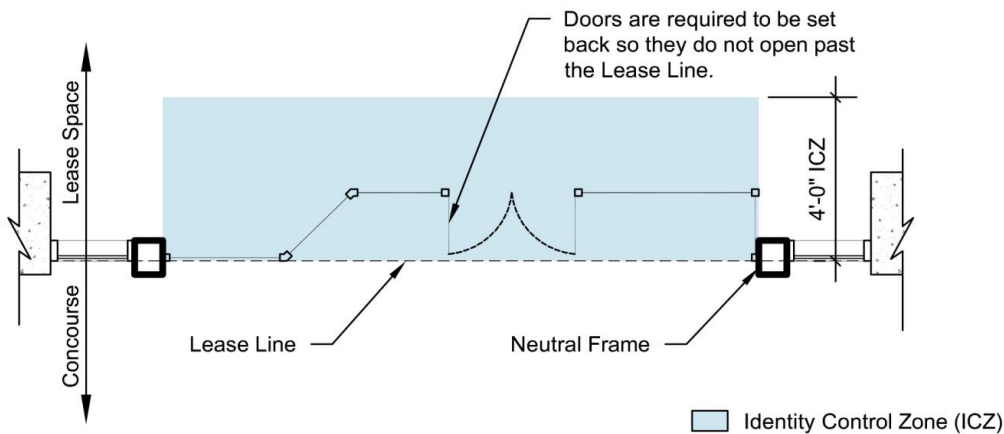

Entry Plan
Figure 3.05

3.1.2 Merchandise Displays

The storefront control zone is the area behind the storefront where merchandise is displayed. Because this is where the customer receives his first full impression of the store, it is critical that special attention be paid to the area through the use of fixtures, raised platforms, props, furniture, mannequins, etc. These elements are to be consistent with the space in both design and materials. The Airport controls the use of windows and determines the appropriateness of their location.

The design of Merchandise Displays is critical in expressing the theme of the retailer. Displays must be 34 inches high and have a toe space 6 inches high and 4 inches deep. Display cases may compose 25% of the counter frontage when not exceeding 4 feet - 6 inches in height above finish floor. Lower display cases may compose up to 75%, with Airport approval. All displays are to consist of durable, high quality material that relates to a common design theme. Acceptable materials include:

1. Solid surfacing plastics .
2. Glass
3. Hard Surface or stone like materials.
4. Stainless steel and other kinds of metal.
5. Wood
6. Porcelain or tile

The fixture layout should allow for passengers with hand-held luggage, bag carts, and baby strollers, as well as persons in wheelchairs who need maneuvering room. Any equipment used in the store visible to the public must be compatible with store design.

1. Displays must be set back a minimum of 1'-6" from the lease line to provide adequate circulation and queue space.
2. All Displays visible to the public are restricted to durable, non-porous, easily cleanable materials. Display unit backing, front, shelving and countertop materials are limited to the following:
 - a. Stone
 - b. Metal
 - c. Solid surface materials
 - d. Glass
 - e. Ceramic or porcelain tile
3. Simulated natural products and metal and plastic laminates are not acceptable materials for display design. However, high impact laminates may be allowed but are subject to DFW Concessions approval.
4. Display recesses, angles, and other devices can be used to break up the length of the flat front.
5. All displays are to have a 6" high recessed toe space by 4" deep. The face of this base should be covered in the same material as the adjacent floor or other durable material. No laminate or rubber base allowed.

6. A personnel access door in a merchandise display front is permissible where no rear entry is available. It must be concealed by matching the adjacent display front materials. Hinges and hardware must be concealed.
7. All take-away counters must have a section that meets TAS/ADA Accessibility requirements.

3.1.3 Flooring Materials and Transition

The level of the finished floor within the shell space is to correspond exactly to that of the adjacent existing concourse finished floor at the lease line, unless prohibited by existing conditions and approved by DFW Concessions. If approved by DFW Concessions, the tenant is responsible for providing a code compliant transition between the lease space floor level and building floor level. Depressed floor slabs will not be permitted. All structural modifications and in-fills must be approved by DFW Concessions.

Stone, ceramic tile, marble, terrazzo or wood are acceptable flooring materials. The use of vinyl, VCT (exception noted for all Shoe Shine spaces), floor paint, sealed concrete, laminate flooring, or cork is not permitted in public areas. Certain floor materials may be considered for approval by DFW Concessions in special cases. Tenants occupying Design Conditions B2, B3 and B4 may request, during lease negotiations coinciding with the TRIP program that DFW not provide base building terrazzo.

The tenant must provide a durable, continuous base at all walls within the lease space. The material must compliment the flooring and be compatible with the storefront. Rubber, vinyl, soft woods and carpet base are not acceptable in any area within public view.

In all food preparation areas, bars, and grab & go areas, a continuous waterproofing membrane must be installed prior to the finish floor material. This material must wrap 12" up on the cement board of adjoining walls. There must be waterproofing under bars and Grab & Go areas. The floor must be flood tested and witnessed by the projects Tenant Project Manager (DFW).

The tenant is required to repair and replace adjacent concourse terrazzo within the entry zone at front of storefront enclosure to provide a continuous floor material, if damaged has occurred during construction. (Refer to Figure 3.06)

If the tenant's space requires floor penetrations, the tenant's contractor is required to x-ray the floor before cutting, drilling, or otherwise penetrating the existing composite slab. The TPM is to be notified of the exact location, in writing, prior to any penetration.

The tenant is to control water from drilling or cutting operations. Surfaces below such operations must be protected. The tenant is responsible for the cost of any damages sustained in such procedures.

Tenants are not permitted to construct mezzanines or raised platforms in the leased premises without the written approval of DFW Concessions. Display cases are an exception.

Food and Beverage tenants required to provide a railing around the perimeter of their seating area (refer to LOD for specific locations) may provide at their option an alternate applied flooring, to be approved by DFW Concessions, over the existing terminal terrazzo. This flooring must preserve the terrazzo below and transitions must be provided per figure 3.07 and TAS/ADA requirements.

Terrazzo Cleaning and Protection: Tenant is required to meet or exceed the appearance of the terminal terrazzo floor. Wash surfaces with cleaner according to National Terrazzo and Mosaic Association's (NTMA) written recommendations and manufacturer's written instructions; rinse surfaces with water and allow them to dry thoroughly. Seal surfaces according to NTMA's written recommendations, and apply sealer according to manufacturer's written instructions.

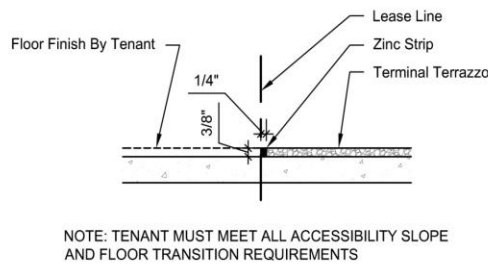

Section Detail
Figure 3.06

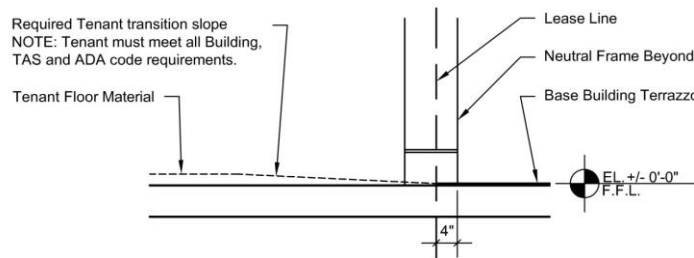

Section Detail
Figure 3.07

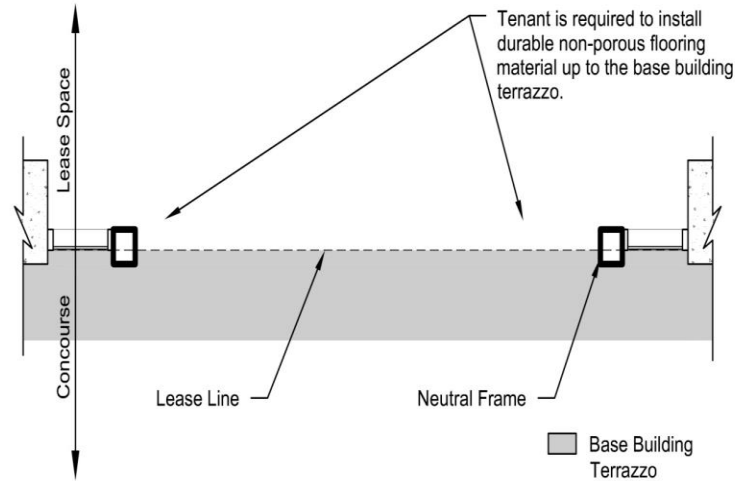

Plan Detail
Figure 3.08

3.1.4 Ceilings

The overall ceiling height within the lease space, including ICZ area, is to be a minimum of 9'-0" and a maximum of 12'-6" if existing conditions permit. Open ceilings or exposed structure treatments are not allowed. All ceiling material must be noncombustible, equal to Class A installation. Ceiling finishes must have a flame spread rating to meet current code requirements. The plenum must be accessible.

Ceiling furr-downs or bulkheads are permitted. However, furr-downs or soffits must insure access to plumbing or HVAC equipment either through design placement or access panels.

All damage to existing concourse ceilings will be repaired at the tenant's expense. Ceilings in food and beverage spaces are to comply with all governing Health Department requirements.

The following are specific requirements for ceiling conditions:

- Tenants are to limit gypsum board soffits and ceilings that are furred down. Stained wood beams or gridded soffits are ways to add interest to the ceiling. Ceilings must be accessible for maintenance. Other materials may be approved by DFW Concessions.
- A 2'x2' tegular grid system is a minimum standard for lay-in ceilings in public areas; a 2'x4' grid system may be used in back of house areas. All ceilings are subject to DFW Concessions approval.
- All grills and diffusers are to be flush mounted in the ceiling and painted to match. All access panels must have an insert of the ceiling finish material.

3.1.5 Interior Walls and Doors

All finishes on interior walls and doors are subject to DFW approval.

1. Materials are to be impact resistant, soil resistant, and have a permanent lasting appearance.
2. The following materials are not permitted within the tenant leasehold:
 - a. Imitation natural materials, such as simulated wood, brick, or laminate.
 - b. Pegboard walls or fixturing systems.
 - c. Painted gypsum board surfaces below 48".
 - d. Window coverings.
 - e. Slat wall material.
 - f. Re-used or recycled lumber is subject to DFW approval.
 - g. Siding composed of wood, vinyl, aluminum, or Masonite.
 - h. Rough sawn cedar or other unfinished woods.
3. Interior doors must be solid core or hollow metal and the quality of the finish should be similar to that of the walls. Kick plates and door closers are recommended.
4. Non-monolithic materials such as thin set tile or sheet goods that are used where exposed outside corners occur must have integral corner guard treatments from the manufacturer or a stainless steel guard from the floor to a height of 48".
5. Stainless steel ball bearing hinges are required on all doors.
6. Food preparation areas must have cement board extending from the floor up to 1'-0" to accept the waterproofing membrane. Water resistant drywall should begin at the cement board 1'-0" above finish floor and is required on all walls.

3.1.6 Demising Walls

The base building will provide demising walls as indicated on the lease exhibits. The tenant is required to maintain separation requirements as reflected in the lease exhibits. If fire rated walls or other existing construction must be opened or cut through to extend services to a lease space, the tenant must preserve the original rating and construction.

All tenant walls are to be finished. Tenants requiring security protection may install expanded wire mesh or weld wire fabric within the return-air opening above walls.

Tenants must provide sound attenuation in demising walls and comply with acoustical requirements in the demising wall per **Section 3.7.2: Sound Transmission Class (STC) Planning Matrix**.

Permanent attachment to concrete beams and column structure must be approved by DFW Code Compliance. Tenants are permitted to fur-out around columns with systems that are self-supporting or freestanding within their lease space. If heavy shelving or attachments are to be installed, the demising wall must be reinforced.

3.1.7 Security

Tenants are required to provide a means of securing the leasehold during non-operational hours. This requirement is for any walled or enclosed spaces within the leasehold. Food and Beverage Open seating areas are not subject to this requirement.

All doors or enclosure panels must be either glass or framed glass and must match or complement the airport provided neutral frames and transitions at each storefront. No security gates or grilles will be allowed.

Enclosed storefronts are encouraged to provide either hinged doors or pivoting doors in keeping with the material and visual requirements within this section.

Open storefronts will have folding, sliding, pivoting or hinged doors and panels in keeping with the material and visual requirements within this section.

Fire Department access requires that all doors and accesses be keyed for admittance from the Concourse. The tenant must furnish cores with keys that match the Airport's Master Key System.

3.2 Shoe Shine Tenants

Shoe shine spaces have Airport provided painted walls, VCT flooring, lay-in ceiling, cove base, power outlets and telephone/ data connections in the lease spaces. Provided finishes must be replaced if damaged.

3.3 Food and Beverage Tenants

3.3.1 Design Guidelines

Following are specific storefront design guidelines:

1. Food and beverage tenants are required to meet all Health Department Requirements.
2. Food and beverage tenants are required to use nonporous, cleanable materials for ceilings above the preparation and serving areas.
3. If the food tenant preparation area is an integral part of the visible service area, it must meet all storefront criteria for finishes and lighting. If the food tenant preparation area is not intended to be part of the visible service area, a separation wall is required, and all doors must have automatic

- closers. Any food pass-through openings are to be minimal in size and are subject to DFW Concessions approval.
4. Any clutter or unsightly equipment such as boxes, shelves, sinks, etc. is to be fully concealed from public view.
 5. Pay particular attention to the visual organization of the rear and side walls of the preparation and serving area. Equipment catalog cut sheets and layouts are to be submitted for approval.
 6. Floors in kitchens, food preparation and storage areas, counter and beverage service areas must be installed over a membrane waterproofing system that results in a fully waterproofed surface, including a 6" high cove base backed with the membrane waterproofing that continues 12" up adjoining walls.
 7. Walls around mop sinks are required to have waterproofing and stainless steel around mop sink to 48" a.f.f.
 8. Must provide a location for the yellow grease cart inside the b.o.h. area as prescribed by the concessions department.
 9. Tenant must provide an area for trash staging in b.o.h. area to prevent overflow of dining area trash receptacles.
 10. All alcohol must be secured in-place with permanent locking mechanism, nightly relocation of alcohol to b.o.h. areas are not acceptable.
 11. The tenant is responsible for verifying what is below, beside and above the tenants space and to avoid conflicts and adverse adjacencies.
 12. Convenience power is required at bars, booths and community tables.

3.3.2 Take-Away Counters

Take-away counter design requirements:

1. Counters must be set back a minimum of 3'-6" from the lease line to provide adequate circulation and queue space. The design should require customer queuing to be parallel to the storefront and not perpendicular into the concourse. Additional setback may be required above 3'-6" in high traffic areas to avoid queuing in concourse.
2. All counters and back walls visible to the public are to be restricted to durable, non-porous, easily cleanable materials. Counter front and countertop materials are limited to the following:
 - a. Stone
 - b. Metal
 - c. Solid surface materials
 - d. Glass
 - e. Ceramic or porcelain tile
3. Simulated natural products and metal and plastic laminates are not acceptable materials for counter tops. However, high impact laminates may be allowed at counter fronts subject to DFW Concessions approval.
4. Counter recesses, angles, and other devices can be used to break up the length of the flat front.

5. All counter fronts are to have a 6" high recessed toe space by 4" deep. The face of this base should be covered in the same material as the adjacent floor or other durable material.
6. Trash receptacles for customer use must be concealed or built into the countertop millwork.
7. Napkins, condiments, utensils, straws, and trays must be set back a minimum of 6" from the front of the counter and dispensed from permanent holders recessed into the front countertop or adjacent area.
8. A personnel access door in a counter front is permissible where no rear entry is available. It must be concealed by matching the adjacent counter front and countertop materials. Hinges and hardware must be concealed.
9. All take-away counters must have a section that meets TAS/ADA Accessibility requirements.
10. The design of the vertical surface of the counter must be consistent all the way across and may not be interrupted by reach-ins or other equipment.

3.3.3 Grab & Go Units

Grab & Go areas may be built-in as a part of the overall concept or freestanding. All built-in areas and freestanding units must be approved by DFW Concessions Department.

Built-in Grab & Go Areas design guidelines:

1. A Grab & Go area incorporated into the overall concept must have a setback of 3'- 6" or more from the lease line or more; this allows for queuing area and does not impede with the normal operations in the terminal.
2. Additional signage for the Grab & Go area will require approval from the DFW Concessions Department.
3. Maximum counter height is 34" AFF.
4. All units must have a 6" high recessed toe space by 4" deep. The face of the base should be covered in the same materials as adjacent floors, materials which are a part of the overall concept, or stainless steel.
5. All walls and surfaces visible to the public are restricted to durable, non-porous, easily cleanable materials. Materials are limited to the following:
 - a. Stone
 - b. Metal
 - c. Solid surface materials
 - d. Glass
 - e. Ceramic or porcelain tile
6. Simulated natural products, metal and plastic laminates are not acceptable materials for counter tops.
7. High impact laminates may be used on the unit side and front if edges and corners are properly treated with corner guards or metal edge trim. All materials are subject to approval by DFW Concessions.
8. Laminates are not permitted on toe-kick areas of displays, counters or other furniture unless formal permission is given in writing.

9. If provided, trash receptacles for customer use must be concealed or built into countertop millwork or enclosed in furniture that is in-keeping with the design of the space and meets the design requirements for counters.
10. Counter top displays, trays, racks, shelving must be set back a minimum of 6" from the front of the counter and must remain neat and orderly and properly stocked.
11. A personnel access door in the countertop is permissible. It must be concealed by matching the adjacent counter front and countertop materials. Hinges and hardware must be concealed.
12. Freestanding units may be incorporated into the design; however, they must be finished or clad in the same materials as the overall concept. See specific requirements for freestanding units below.
13. The design of the vertical surface of the counter must be consistent all the way across and may not be interrupted by reach-ins or other equipment.

Freestanding Units must use the following guidelines when designing:

1. All units are to have a 6" high recessed toe space by 4" deep. The face of this base should be covered in stainless steel.
2. All Grab & Go units must meet TAS/ADA Accessibility requirements.
3. Units may be no more than 48" tall unless they are a standalone unit placed against a solid full height wall.
4. To maintain proper circulation and queuing, unit must be set back 3'- 6" or more from the lease line, unless it is a standalone unit placed against a solid full height wall. This allows for queuing and does not interfere with normal operations in the terminal.
5. No company logos or product signs are attached to unit.
6. Unit must be finished or clad in the same materials as the overall concept.
7. Standalone units placed against a solid full height wall need DFW Concessions approval.

3.3.4 Display

Following are specific requirements for display of food and beverages:

- Front counter - The use of built-in glass display cases is allowed. They should be a maximum of 5'-0" high above finish floor and must be constructed of a clear glass front, with stainless steel, brass, or other bright metal, and must sit on a standard 6- inch base. The width of display cases cannot exceed 25% of the counter frontage. Pre-fabricated display cases on countertops are not allowed.
- All display cases must be lighted and vented. Light sources must not be visible. The sides and back of the case may be mirrored.
- No displays or signs are permitted in the public concourse beyond the Identity Control Zone.
- Back counter - storage units or pre-fabricated display cases may be installed at the tenant's option at the back of the service area. Any such unit must adhere to the counter or display case specifications mentioned for materials above, except storage counter doors must be polished stainless steel.

3.3.5 Equipment

Tenant equipment on counters is to be set back a minimum of 6" from the front counter edge and recessed into the countertop so that no portion exceeds 4'-6" high above finish floor. Self-serve soda machines may exceed this height upon review and approval of DFW Concessions but may not block the view of the counter. Beverage machines and other miscellaneous equipment on the counter are subject to design review. No used equipment, simulated wood finishes, nor trademark or supplier logos will be permitted on equipment within public view. Tenants must provide new equipment. No re-use of existing equipment is permitted.

Equipment cords and unfinished equipment backs should be screened from public view at all times, including transaction computers and printers. All paper goods and supplies are to be stored in areas not visible to the public.

3.3.6 Lighting

All lighting within the food and beverage lease space must meet all code and Health Department requirements, as well as the TDM lighting requirements **(Reference Section 3.6, "Lighting")**

3.3.7 Storage

The tenant's supplies must be stored on appropriate racks or in cabinets within the tenant's lease space. Such storage must be concealed with doors or sliding panels from public view. In addition to storage within the lease space, tenants have an option to lease remote storage space, when available. Modification and/or creation of new storage locations will require building permits.

3.3.8 Allowance for Grease Storage

A 55 gallon drum must be allowed for in kitchen area. Food and Beverage tenants having cooking facilities with "cooking oil management" concerns, shall find access elevators leading to designated "oil reclamation" areas on the Ramp and Concourse plans provided for each terminal. **(Reference Section 2.1.1, "Ramp Level")**

Related Criteria: **Reference Section 2.1.2 Concourse Level**

3.4 Railings

Where the tenant lease line extends past the neutral frame, tenants shall be required to provide railing to define the seating area or merchandise display area. Food and Beverage tenants serving alcohol will be required to meet Texas Alcoholic Beverage commission railing requirements. The railing shall be procured and installed by the tenant at the tenant's expense and comply with the following;

Specific Requirements: **Reference Section 3.4.1., "Railing Construction Criteria"**

General Requirements: **Reference Section 12.0 Specifications/ Section 05 73 00**

(Related Requirements: **Reference Section 3.5.3.5 "Railing Signage", 3.5.3.6 "Railing Signage Criteria" & 3.5.3.7 "Railing Signage Configuration"**

3.4.1 Railing Construction Criteria
see specifications in index of this document

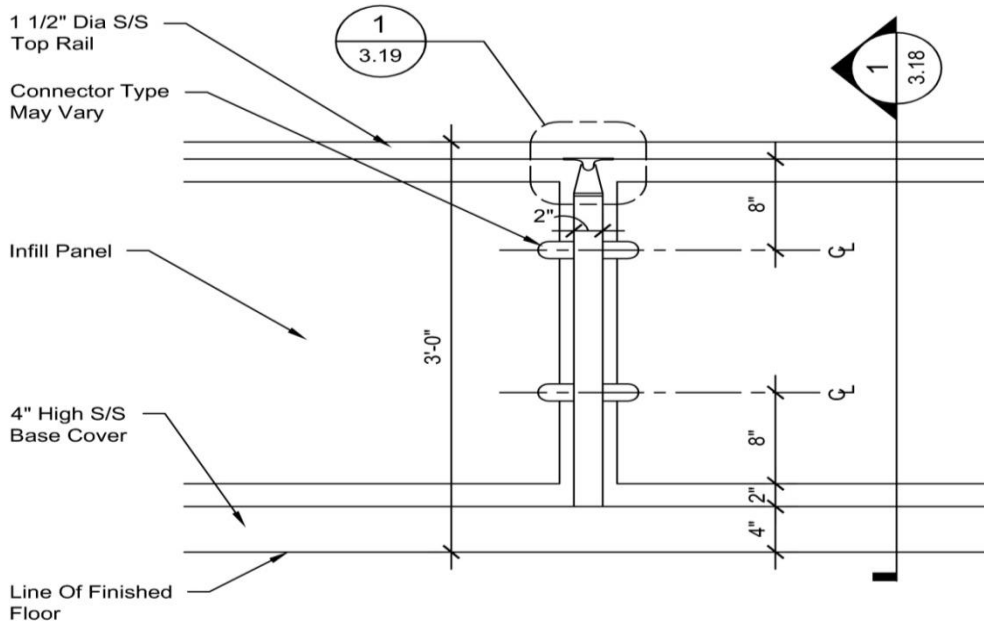

Plan Elevation
 Figure 3.09

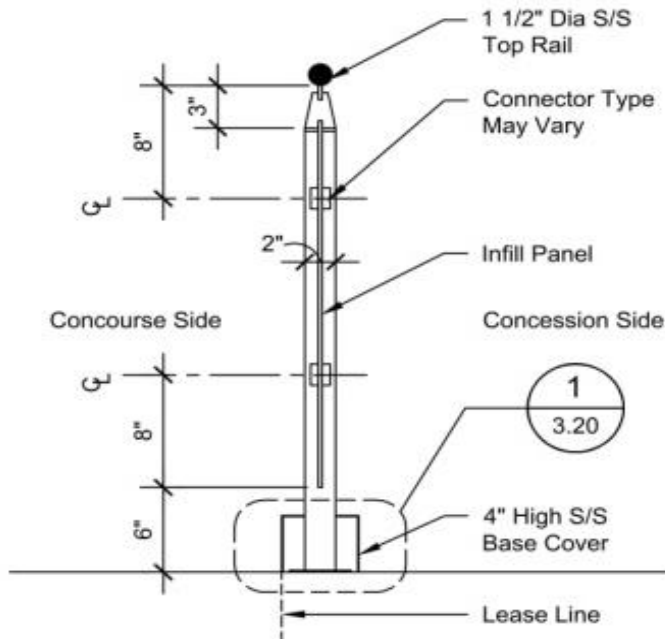

Plan Section
 Figure 3.10

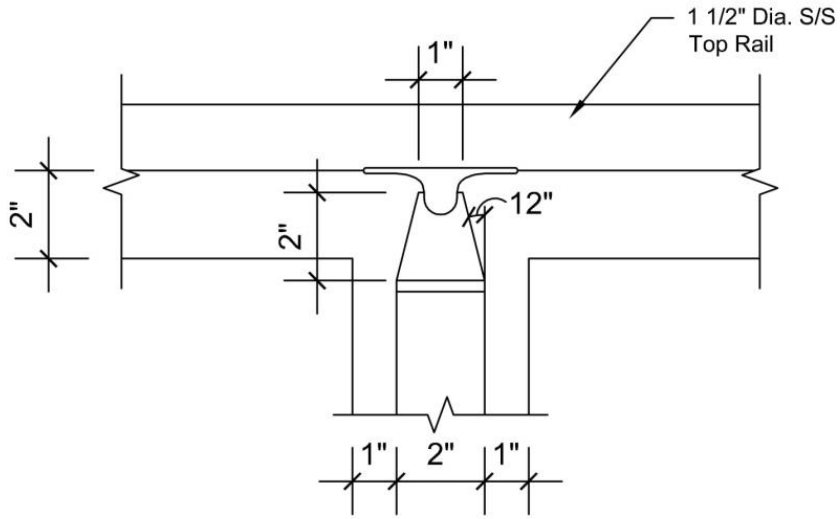

Plan Detail
Figure 3.11

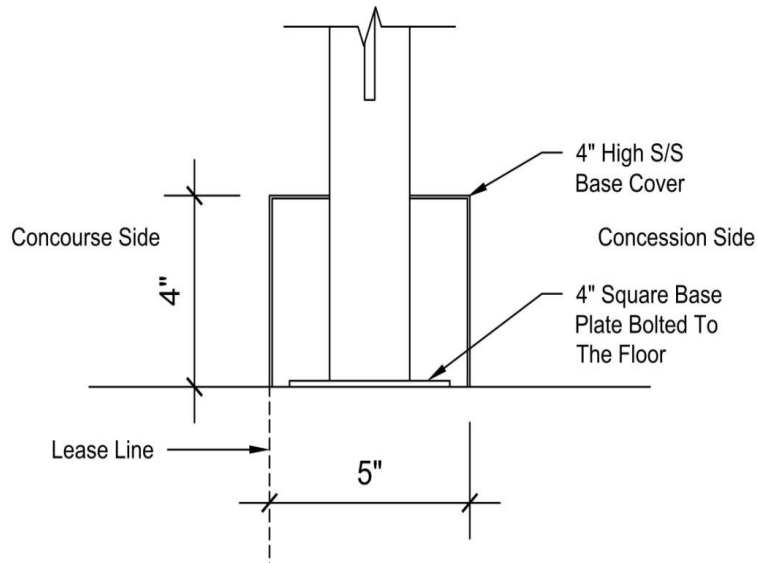

Plan Detail
Figure 3.12

3.5 Signage Criteria

Signage is an integral part of the overall design of the concourse and plays a key role in the retail environment. Tenants are encouraged to be innovative and creative in their signage design and are permitted to use their corporate logo, sign type, and lettering styles, when compatible with this Manual. Tenants are required to coordinate mandatory and supplemental signage into a complementary design. Tenants must be aware of the Airport directional signage in each Terminal and avoid obstructing or confusing the Airport's way finding message.

Concession signage standards define types of signage, maximum size of fonts, materials, and lighting requirements.

Regardless of location, all signs, including colors, materials, and designs are subject to DFW Concessions approval.

3.5.1 General Requirements

In addition to specific signage criteria available through the TPM, tenants must comply with the following general criteria:

1. Mandatory blade signage is required at all airside storefront elevations per the guidelines outlined in the design conditions. On Elevations in excess of 40 linear feet, additional signage may be permitted only with the Airports prior approval. Any tenant having storefronts on two or more sides of the concourse may use one sign on each storefront, refer to the design criteria for each location. All Signage approvals are at the discretion of the airport. (Refer Section 3.5.3.1 Blade Signage.)
2. Length of Signage shall not exceed 60% of the signage zone
3. Brand names, product names or phrases may not appear on the storefront or store enclosure unless approved by DFW Concessions.
4. Letter height – The maximum cap height for horizontal and vertical text letters is 12". Tenants requesting letters over 12" must have prior approval from the TPM. Capital letters may be 18" when lower case letters are 12". Signage of all capital letters must all be 12".
5. Logos may be up to 24" tall, must have approval of the TPM.
6. Decals or other signage indicating product lines or credit card acceptability is not be permitted on the storefront.
7. Temporary signs, banners, sales notices, etc. are not permitted on the storefront.
8. All attachment devices, wiring, clips, transformers, lamps, tubes and other mechanisms required for signs must be concealed.
9. Electrical service to tenant's signs is to be supplied from tenant's electrical panel.
10. The location of all openings for conduits and sleeves in sign panels should be indicated by the tenant's sign contractor on signage shop drawings

submitted to the TPM for review and approval. The sign contractor is to install the product(s) in accordance with the approved drawings.

11. Any damage to any other work caused by the tenant's sign contractor will be repaired at the tenant's expense.
12. The tenant will be fully responsible for the workmanship and installation of tenant's sign and coordination of the sign contractor.
13. No sign fabricator labels or other identification will be permitted on the exposed surface of the signs, except those required by local ordinance. If required by local ordinance, such labels or other identification should be in an inconspicuous location.
14. "Operated By" signage will only be allowed inside the location, not on the storefront or in the SCZ.

3.5.2 Sign Materials and Construction

The following sign types are appropriate and their use is permitted with DFW Concessions approval. Note that all signage types must be illuminated:

1. Dimensional, wood, metal, plastic, glass or other material with a permanent appearance.
2. Dimensional, illuminated, halo or back-lit individually mounted letters.
3. Dimensional letters must not be less than one inch nor more than three inches in depth, and must project from the storefront with one-inch spacers.
4. Etched, beveled, sandblasted or stained glass.
5. Internally illuminated channel letters with opaque metal sides and plastic face. Internally illuminated letters must not be less than one inch nor more than four inches in depth. Raceways must be tray or channel, no visible raceways are allowed.
6. Moving, rotating, or animated signs may be used in the Identity Control Zone with DFW Concessions approval.

The following sign types, sign components and devices will not be permitted:

1. Non-Illuminated
2. Boxed or cabinet type.
3. Formed plastic.
4. Cloth, paper, cardboard or similar stickers or decals.
5. Noise making.
6. Odor producing.
7. Flashing.
8. Exposed labels of manufacturers, underwriters, except where required by law. In this instance the concessionaire must take all efforts to conceal labels from view.
9. Veneer or plywood products.
10. Pre-molded plastic letters with reflective coatings.

3.5.2.1 Illuminated Signs

Where illuminated signs are required or considered, the following restrictions apply:

1. All illuminated signs must be turned on during the terminal's retail operating hours. The use of an automatic timing mechanism for signage, Identity Control Zone lighting, and cabinet window lighting is mandatory.
2. DFW Concessions must approve any use of neon.
3. Signs must be constructed so lamps are easy to replace. Ballasts should be accessible from within the lease space and must be concealed.
4. Video equipment used for illustrating products or for advertising is restricted if located within the Identity Control Zone. All video equipment is subject to DFW Concessions approval.

3.5.2.2 Non-Illuminated Signs

Non-illuminated signs are viewed as decorative as well as informative and are subject to DFW Concessions approval. Note the following:

1. Letters or logos applied or painted directly on the inside face of glass storefronts are not permitted unless they are used as a safety band. Height for safety band name or logo should not exceed 4" unless required by code.
2. Super graphic treatment of large amounts of storefront is not permitted.
3. Hand lettered non-professional signs and newspaper advertisements are not permitted in the Identity Control Zone.
4. Additional signs or advertising for brand names (e.g., soft drinks) are not permitted without DFW Concessions approval. All graphics must have a non-glare, matte finish. The type must be large enough and its style simple enough to make the text clearly legible.

3.5.3 Primary Sign Types

Each tenant is required to design, fabricate, install, and maintain primary signage. Each tenant with a blade sign will be required to install 2 blade sign inserts as described in their specific Design Condition (**Reference Section 2.5, "Design Conditions"**), as well as feature wall signage. Blade sign and power for blade sign are provided by DFW.

The following are the primary types of signage for Concessionaires:

- Blade Signage
- Feature Wall Signage
- Vertical/Jamb Signage
- Wall Signage
- Railing Signage
- Bulkhead Signage

3.5.3.1 Blade Signage

Blade signs will be provided for all airside tenant design conditions, U.N.O. Each tenant will be provided 1 double-sided blade sign at the front of their lease space except for tenants located exclusively under a wedge. Wedge conditions will get a one-sided sign on either side of the wedge. Landside blade signs will not be provided. Tenants must provide 2 flat panels to be inserted into the sign framework provided. Blade sign and power for blade sign are provided by DFW.

(Reference Section 2.2, “Design Conditions” for location and sign size)



Blade Signage
Figure 3.13

3.5.3.2 Feature Wall Signage

The feature wall sign is located along the storefront and is displayed parallel to its face. Tenants may provide a feature wall sign displaying the store name where opening height allows. The feature wall signage band should be clad on all exposed sides (face, bottom and sides) in one of the following materials: glass, metal, stone, tile, and wood or other appropriate material. Painted gypsum board as a feature wall sign background will not be permitted. Other materials may be permitted with approval from DFW Concessions.



Feature Wall Signage
Figure 3.14

3.5.3.3 Vertical/Jamb Signage

Vertical/jamb signage may be provided by the tenant perpendicular to the storefront at the store entrance or edge of the neutral frame. The following are design requirements specific to the vertical/jamb signage:

1. The tenant's store name or logo may appear within the jamb signage zone.
2. Illuminated signs below 7' must not be heat-producing.
3. All signs must be tamper-proof.



Vertical/Jamb Sign
Figure 3.15

3.5.3.4 Wall Signage

As designated in the L.O.D., tenants may be allowed wall signage on the hold lounge wall perpendicular to the Neutral Frame opening. Signage can have a maximum 2" projection from the wall and is limited to the area specified in the L.O.D. Tenant may not alter the terminal provided floor base at this location. Illuminated signs below 7' must not be heat-producing. All signs must be tamper-proof.

Wall Sign
Figure 3.16

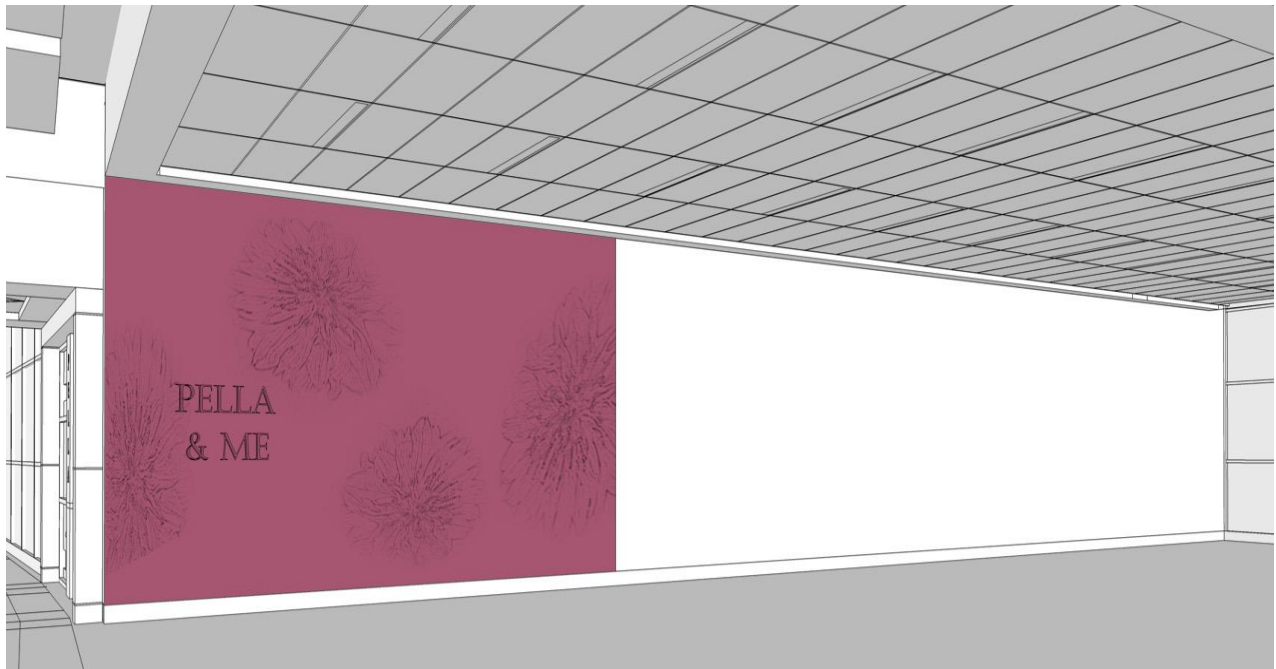

3.5.3.5 Railing Signage

Open “un-walled” customer seating areas or merchandise display areas are located in or adjacent to SkyLink nodes, near entrances to SkyLink stations and within a select number of in-line, concourse facing concession units. These seating areas must be enclosed by concessionaire provided railings. Within these railings, opportunities exist for signage.



Rail Sign
Figure 3.17

Four types of signage opportunities exist:

*All signage must comply with criteria in **Section 3.4.1, 3.5.3.6 & 3.5.3.7** Design and locations for shared signage opportunities must be mutually agreed upon between the tenants and approved by DFW Concessions. Costs for railing signage will be shared between the concessionaires.*

1. Single tenant signage for concessions located in SkyLink **(Refer to Diagram 3.19)**
Single tenant concessionaires located at the intersection of the concourse and entry corridor to the SkyLink station are allowed a total of three signs.
 - One “entry sign” is allowed within the railing module immediately adjacent to the main entrance of the concession unit.
 - Two “corner signs” are allowed within the two railing modules at each side of the corner condition.

2. Single tenant signage for in-line concessions facing concourse (**Refer to Diagram 3.20**)

Single tenant in-line concessionaires facing the concourse are allowed one sign.

- A single sign is allowed within the railing module immediately adjacent to the main entrance of the concession unit.

3. Shared tenant signage for concessions located in SkyLink (**Refer to Diagram 3.18**)

Shared seating areas located at the intersection of the concourse and entry corridor to the SkyLink station are allowed a total of four signs (two per concessions unit).

- One “entry sign” is allowed within the railing module immediately adjacent to the main entrance of each concession unit.
- One “corner sign” per concessionaire (two total signs) is allowed within each of the two railing modules at each side of the corner condition.

4. Special Condition

Uniquely shaped seating areas which do not contain corner conditions, and are significantly smaller than conditions 1, 2 and 3 will be determined on a case by case basis. Quantity and location for signs must be mutually agreed upon between the tenant(s) and DFW Concessions. In the event these areas are shared between two tenants design and locations for shared signage opportunities must be mutually agreed upon between the tenants and approved by DFW Concessions. Costs for railing signage are the sole responsibility of the concessionaire(s). All signage must comply with criteria in **Section 3.4.1, 3.5.3.6 & 3.5.3.7**

3.5.3.6 Railing signage criteria

Tenants are encouraged to be creative with the design of railing sign panels and are permitted to use their corporate logo, graphics and lettering styles. All signs, including colors, materials, and designs are subject to DFW Concessions approval.

General Requirements:

Tenants must comply with the following general criteria:

1. Each sign panel must fit within one railing module.
2. Brand names, product names or phrases may not appear on the sign panel unless approved by DFW Concessions.
3. Decals or other signage indicating product lines or credit card acceptability is not be permitted sign panel.
4. All attachment devices, wiring, clips, transformers, lamps, tubes and other mechanisms required for signs must comply with railing specification **(Refer to Section 3.4)**
5. The sign contractor is to install the product(s) in accordance with the approved drawings.
6. Any damage to any other work caused by the tenant's sign contractor will be repaired at the tenant's expense.
7. The tenant will be fully responsible for the workmanship and installation of tenant's sign and coordination of the sign contractor.
8. No sign fabricator labels or other identification will be permitted on the exposed surface of the signs, except those required by local ordinance. If required by local ordinance, such labels or other identification should be in an inconspicuous location.

Sign Materials and Construction:

The following sign materials are appropriate and their use is permitted with DFW Concessions approval:

- Wood, metal, plastic, glass (etched, beveled, sandblasted or stained) or other material with a permanent appearance that fits within prescribed mounting system.

The following sign types, sign components and devices will not be permitted:

1. Illuminated
2. Dimensional letters
3. Noise making.
4. Odor producing.
5. Exposed labels of manufacturers, underwriters, etc.
6. Veneer or plywood products.
7. Pre-molded plastic letters with reflective coatings.
8. Hand lettered non-professional signs

3.5.3.7 Railing Signage Configuration

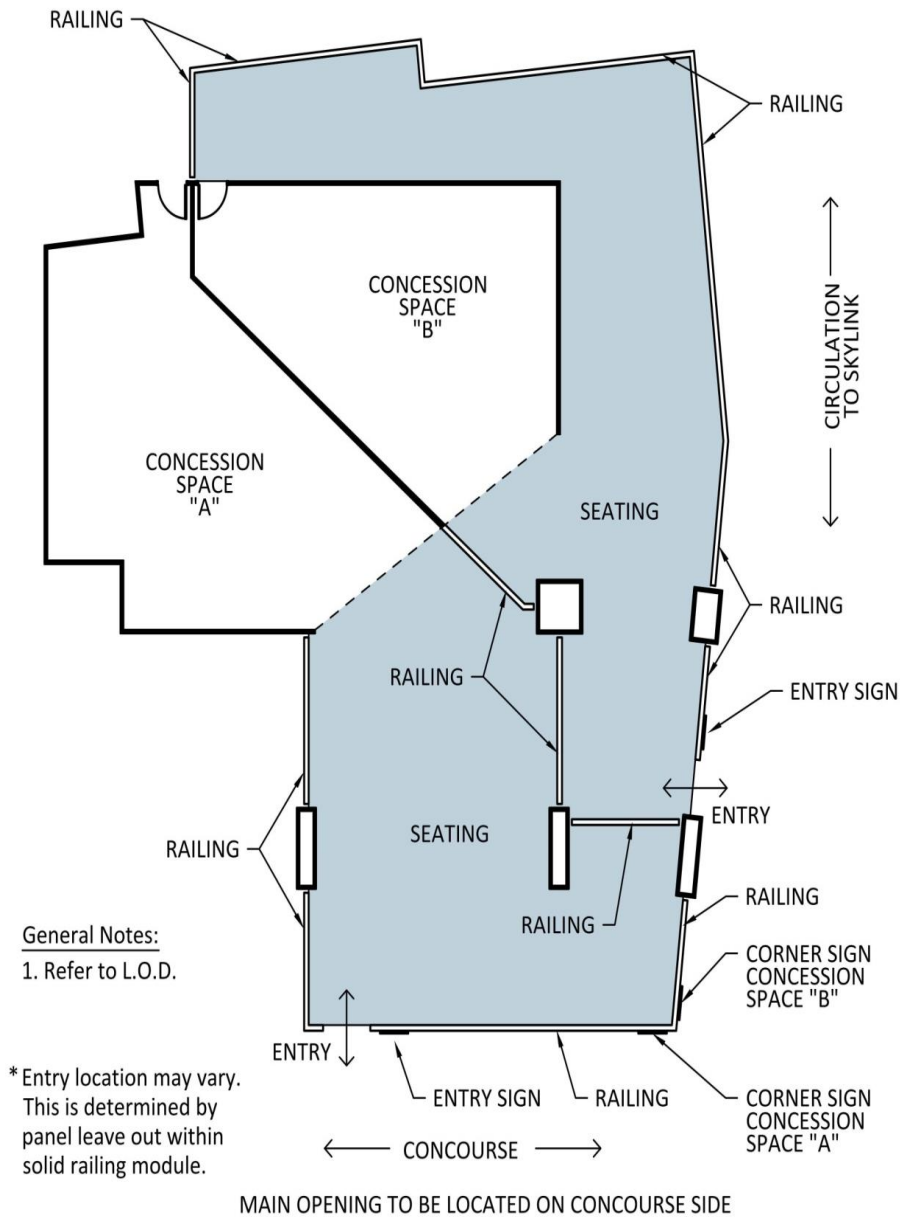

Shared Seating Area
Figure 3.18

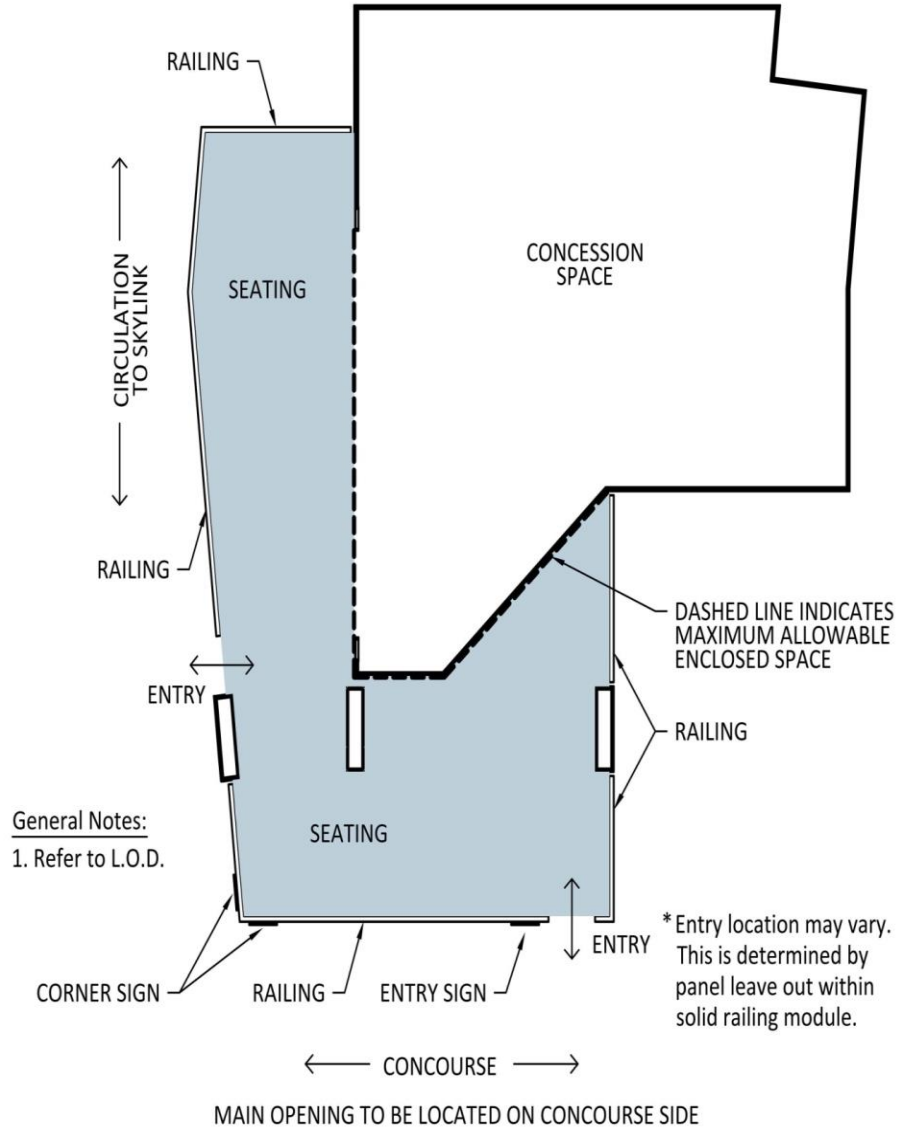

Unshared Seating Area
Figure 3.19

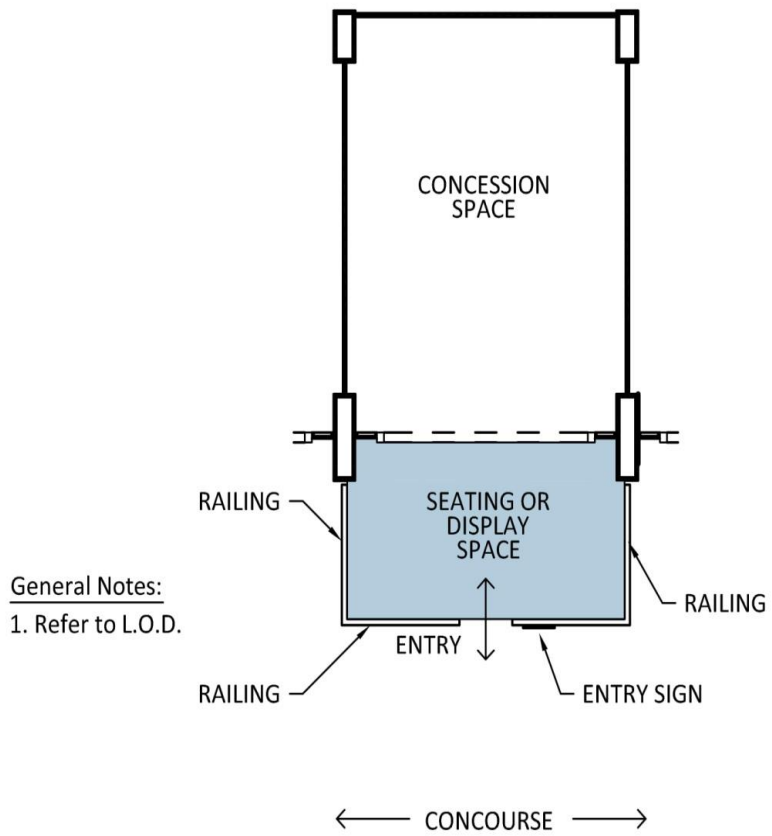

Unshared Inline Seating Area
 Figure 3.20

3.5.3.8 Bulkhead Signage

Bulkhead signs are required in the B2 and B3 Design Conditions. The bulkhead is a structural beam within the tenant lease space at column line E (facing the concourse) which is to be concealed and integrated into the overall tenant design. The bulkhead signage should be clad on all exposed sides (face and bottom, and sides) in one of the following materials: glass, metal, stone, tile, and wood or other appropriate material. Painted gypsum board as a sign background will not be permitted. Other materials may be permitted with approval from DFW Concessions. The Bulkhead Sign must be continuous between the structural columns.

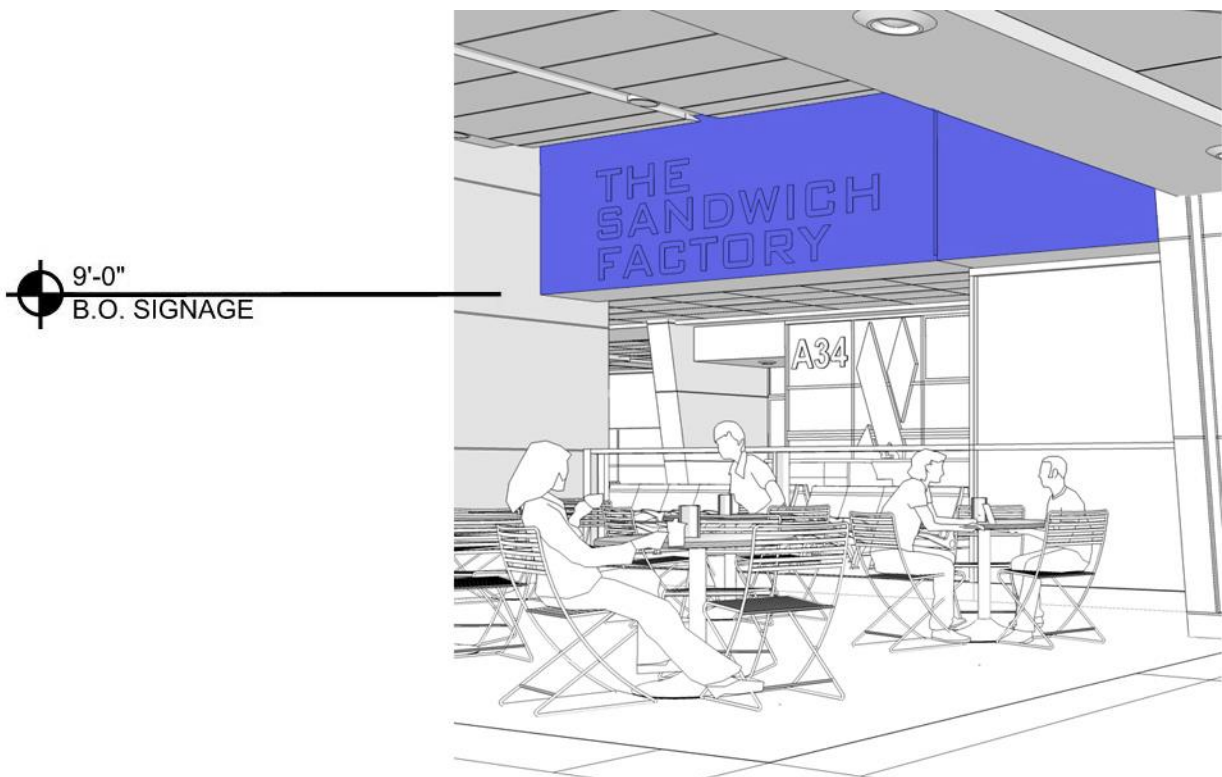

Bulkhead Signage
Figure 3.21

3.5.4 Specialty Signage

All signage on and within the tenant's space is subject to design review and approval, including all signs for sale and seasonal promotions, and for product displays. DFW Concessions must approve signage of this type before it is installed.

Signage must be professionally designed and produced in colors and materials consistent with the overall store image. No freestanding floor signs (stanchion signs, A-frame signs, etc.) will be allowed.

3.5.5 Menu Boards

Food and Beverage tenants are to provide one or more menu boards designed as an integral part of the design concept.

Menu boards must be digital, with changeable price and menu graphics. Additional signage on menu boards is limited to a designated logo, point-of-sale graphics, and trade name only. Text on the menu boards must be legible from the front counter. Tenants are encouraged to use electronic menu boards consisting of one or more flat-screen monitors (max depth 4") integrated into the rear wall design.

Menu boards are not permitted within the Identity Control Zone. DFW Concessions must approve the use of menu board photographs. The graphic design of the menu board is to match the storefront identity in type style and colors.

"Daily Special" signs or signs for seasonal or temporary promotions may be integrated into the overall design of the menu board and the back wall.

The board must be a minimum of 1'-6" from the adjacent demising wall.

3.6 Lighting Criteria

3.6.1 Lighting Technology

High efficiency lamps with color temperatures between 2700 degrees Kelvin and 3500 degrees Kelvin with a Color Rendering Index of 80CRI or higher, are required in the Identity Control Zone. Standard sources are linear and compact fluorescent, ceramic metal halide, quartz halogen incandescent, shielded neon, fiber optic and light-emitting diode (LED). Electronic ballasts, low voltage transformers, switches and dimming equipment should be used as required for a complete installation.

Lighting design must conform to the codes adopted by DFW code department. Accent lighting inside the tenant space (not in ICZ) may be outside of ICZ color range. See TPM for additional information.

3.6.1.1 Lighting within the Identity Control Zone

Ambient lighting from the public concourse will not be sufficient for tenant lighting. The tenant lighting will be seen against a background of varied natural and artificial light, and must maintain high standards of quality, which are critical to the effectiveness and operating efficiency of the overall facility.

General ambient light levels at the floor in the Concourse will be approximately 30-50 foot-candles during daylight hours and 20 foot-candles after daylight hours. Contrast ratios listed below should be in relation to these ambient levels.

Storefront Lighting Level Matrix		
	Maximum Contrast Ratio	Minimum Maintained Luminance
Show Windows - General	3:1	150fc
Shop Windows - Display	5:1	300fc
Floor at Shop Entry (Identity Control Zone)	3:1	100fc

The Identity Control Zone is restricted as follows:

1. Light sources utilized for this purpose must be quartz halogen incandescent, compact fluorescent, linear fluorescent, ceramic metal halide, or LED.
2. Track lighting is prohibited.
3. Provide a minimum of 100 foot-candles (fc), maintained at the floor level of the Identity Control Zone.
4. Lights must be selected and placed to avoid glare in the public concourse.

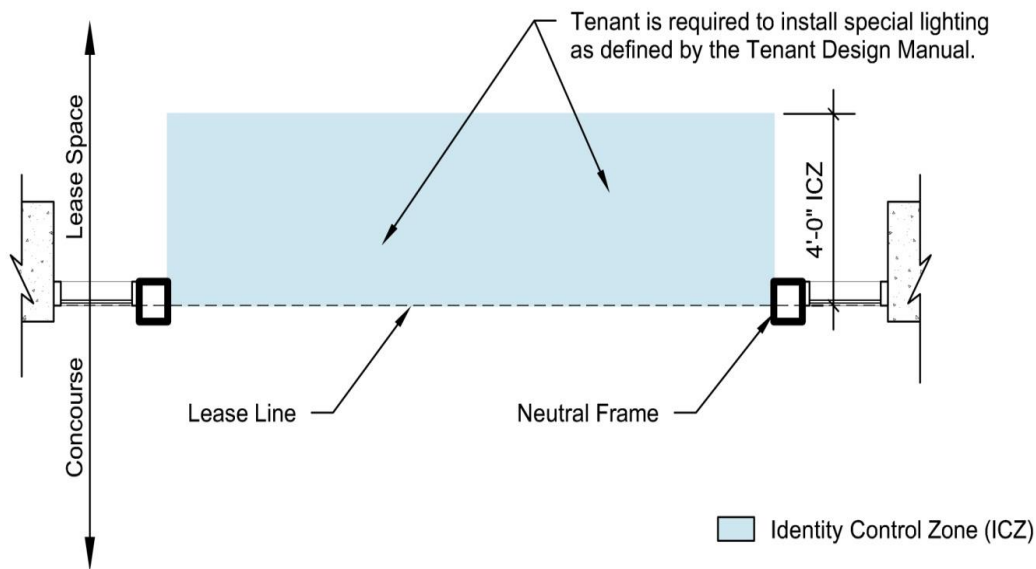

Plan Detail
Figure 3.22

3.6.2 General Tenant Lighting Standards

General lighting refers to interior lease-space lighting that is beyond the Identity Control Zone. Lighting must be compatible with the design of the lease space. Current version of ComCheck must be completed and passed and supplied with permit application (**Refer to section 11.4**).

If linear fluorescent lighting is used, parabolic diffusers with metallic coatings or a white paint finish must be used. Egg crate and prismatic acrylic diffusers are prohibited; however, acrylic prismatic lenses are allowed in food preparation areas outside of public view.

Exposed and surface-mounted lamps are prohibited. All surface mounted decorative fixtures are subject to approval by the TPM. All showcases and display cases must be adequately lit and ventilated.

Track lighting is prohibited, recessed/hidden tracks may be used if approved by the Tenant Project Manager. Recessed directional fixtures may be used in parallel to achieve an equivalent illumination affect.

Non-L.E.D. lighting may be used only for design/feature lighting. General lighting and task lighting must be LED.

3.7 Acoustics and Public Address

3.7.1 Acoustics

Tenants are required to minimize the transmission of sound from their lease space to the concourse and adjacent tenants.

The tenant must provide the following as a minimum:

1. Noise Criteria (NC) Values from the Heating, Ventilation, and Air Conditioning (HVAC) systems as generally accepted practice by the American Society of the Heating, Refrigeration and Air Conditioning Engineers (ASHRAE), Sound and Vibration Chapter 46, Table 34 Design Guidelines for HVAC-Related Background Sound in Rooms, 1999 Edition. NC Level outside a tenant space as a result of the HVAC system should be limited to NC 40 in any adjacent occupied space or landlord lease space.
2. HVAC systems and equipment will be installed with vibration isolators as accepted practice by ASHRAE, Sound and Vibration Chapter 46, Table 45 Selection Guide for Vibration Isolators, 1999 Edition.
3. The minimum Sound Transmission Class (STC) value between tenant spaces for non-critical noise intrusion is STC 47.
4. Minimum partition STC for critical noise adjacencies such as beverage tenants, food preparation, cleaning areas, and dishwashing adjacent to sensitive tenant STC 55 with consideration for plumbing noise vibration isolation. Higher STC values may be required based on space planning. See the STC planning outlined below.
5. Space planning for adjacent tenants will need to be considered and the tenant's Design Team should inquire as to adjacencies.

Music and background paging systems are permitted with DFW Concessions approval. The volume of sound must be controlled to limit the levels to the lease space boundaries and not intrude into adjacent lease spaces or concession aisle ways. The Terminal Background Paging System and Emergency Messaging System must be clearly heard without interference from lease space sound systems. The noise from any lease space to the exterior must not exceed 6 dBA above the ambient level. The ambient level is scheduled to be 50 dBA; therefore, the maximum level for the lease space will not exceed 56 dBA. **(Refer to Section 3.7.3, "Public Address System" and 3.9.2 "Fire Alarm" for further definition regarding electroacoustic requirements.)**

3.7.2 Sound Transmission Class (STC) Planning Matrix

Tenants will be required to maintain a minimum STC rating for the demising walls per the following matrix:

	Business Center	Passenger Service	Concession Storage	News Stand	Quick Serve	Grab and Go	Restaurant	Retail	Terminal	Toilet
Business Center								45	45	
Quick Serve										
Concession Storage			45						40	
News Stand							45		40	50 ¹
Passenger Service							45		40	50 ¹
Grab and Go							45		40	50 ¹
Restaurant				45	45	45				50 ¹
Retail	45							45	45	50 ¹
Terminal	45		40	40	40	40	45	45		
Toilet				50 ¹	50 ¹	50 ¹	50 ¹	50 ¹		

¹ Double wall to isolate plumbing noise

3.7.3 Public Address System

In Terminals A, B, C, and E, the Airport utilizes the Public Address (PA) System as the audible portion of the Voice Evacuation (VE) System. A tie-in point will be available within or adjacent to the lease space to connect into the Terminal PA/VE system.

The tenant is responsible for locating the speakers and circuiting to distribute the VE messages. Speaker placement and circuiting shall be in accordance with all required codes and standards in Section 1.4 "Codes and Standards", including NFPA 72 and the DFW "Construction and Fire Prevention Standards Resolution and Amendments to the Codes".

Specifically, speaker quantities and placement must ensure a Speech Intelligibility Index (STI) of not less than 0.50. Speaker cabling shall be installed in conduit and cabling shall be connected to each speaker in series. Each tenant space shall have a series speaker cabling; there shall be no T-taps, or branch distribution. Therefore, the speakers within the tenant space shall loop back to the original tie-in point so the circuit can extend beyond the tenant space in series. The tenant contractor shall coordinate the design and installation of connections to the tie-in point with DFW DPS, the DFW Fire Marshal's office, DFW Life Safety, and DFW ITS. All devices shall be compatible with the Terminal PA/VE system and be provided by the vendor installing the Terminal PA/VE System.

Ross & Baruzzini will design the space PA/VE system to work with and tie-in to base building system at a rate currently negotiated by DFW Concession. The cost of the design of the PA/VE system will be billed back to the tenant. The tenant's contractor will be required to have the PA/VE system installed by FORD Audio, and cost will be billed back to the tenant.

Refer to 3.9.2 "Fire Alarm" for further definition regarding electro acoustic requirements.

3.8 Mechanical, Electrical and Plumbing Requirements

Terminal A is defined in **Section 7**, Terminal B is defined in **Section 8**, Terminal C is defined in **Section 9** and Terminal E is defined in **Section 10**.

Terminals A, B, C, and E MEP systems will provide a basic level of utility services in accordance with the design standards for the airport that should satisfy most standard project needs. Tenant requirements or unusual circumstances caused by tenant development may demand that supplemental equipment be installed by a contractor qualified to perform work at the tenant's expense. (**Reference DFW Design Criteria Manual**)

Upon lease execution or pre-design kickoff meeting, tenant will receive access to CAD drawings of their individual space to include provided mechanical, electrical, and plumbing for use in preparing design and construction drawings.

Plans must show all routing and connections of new services to existing lines, ductwork, piping, telephones, distribution switchboards, or distribution panels. The tenant must demonstrate that existing utilities will support new lease space design loads, and provide to the DFW code officials completed heat loss/gain and electrical power calculation forms provided in this Manual. **(Reference Section 11.1 Heat Loss Schedule, Section 11.2 Heat Gain Schedule and Section 11.3 Electrical Review Schedule)**

3.8.1 Heating, Ventilation, and Air Conditioning

Terminal A is defined in **Section 7**, Terminal B is defined in **Section 8**, Terminal C is defined in **Section 9** and Terminal E is defined in **Section 10**.

Building HVAC air will be distributed to the lease space via a medium pressure branch connection sized to provide maximum supply airflow of 1.8 cfm/s.f. (at tenant space). The tenant is responsible for supplying supplemental HVAC if additional conditioned air is required due to heating and cooling loads exceeding the provided base building capacities for the lease space. Supplemental HVAC will be achieved with 4-pipe fan coil units, provided and installed by tenant. **(Reference Sections 7.1, 8.1, 9.1 or 10.1, "Provisions Summary", Sections 7.2, 8.2, 9.2 or 10.2, "Responsibility Matrix", and Sections 7.3, 8.3, 9.3 and 10.3, "Concessions Service Matrix")**

The tenant must verify the existing air supply in the field.

A chilled water branch line with supply and return connection points will be extended to the perimeter of the tenant's lease above the concourse ceiling. Chilled water can be used for fan coil unit cooling coils and for water-cooled refrigeration and ice production equipment in the space.

Heating water supply and return branches will also be extended to the tenant's lease space perimeter for use in heating the tenant's space. The heating water piping will extend into the lease space above the concourse ceiling height and terminate with shut off valves. Heating water branches will be provided for all tenant spaces. Heating water should be extended to heating coils on VAV terminals, fan-powered terminals, or fan coil units.

The HVAC design of each lease space must meet the following criteria.

1. Heating – winter inside comfort design temperature: 75°F db.
2. Cooling – summer inside comfort design temperature: 75°F db.
3. Outside design temperatures – As indicated in the current edition of the ASHRAE Handbook of Fundamentals, 2½% conditions.
4. Chilled water coils should be designed for a 28°F temperature differential.
5. The existing maximum supply air to lease areas is calculated at 1.8 cfm/s.f. (this varies in the SkyLink areas). The tenant is responsible for supplying supplemental HVAC if additional air-conditioned air is required due to increased loads in the lease space.

The tenant will provide the engineering design and installation of their HVAC system including the following:

1. All medium pressure ductwork from the main trunk ducts to the VAV boxes, including duct taps and control dampers.
2. Fan powered VAV boxes and modifications to the temperature control system, depending on the existing system in the lease area.
3. All low-pressure ductwork, including that necessary for supply, return air, exhaust, and make-up air.
4. All grilles and diffusers for supply, return air, exhaust, and make-up air.
5. Make-up air units should be tempered and connected to the base building hydronic system.
6. All required controls. All equipment must be compatible with existing direct digital controls (DDC) used in the terminal, however, controls must be updated. Existing controls may not be re-used.
7. A heating system using fan powered VAV boxes with hot-water coils and the required heating-water piping with strainers on incoming water lines.
8. For applicable concession lease spaces, 2" chilled and 1" heated water piping taps have been provided below the third floor level (above tenant ceiling level), to the perimeter of lease space, at the wall closest to the lease line. **(Reference Sections 7.2, 8.2, 9.2 or 10.2, "Responsibility Matrix")** The tenant will be responsible for the extension of the chilled water piping with strainers on incoming water lines.
9. Supplemental cooling and heating. All supplemental cooling and heating service must be designed by the tenant's engineer and installed by a qualified contractor. Supplemental HVAC must be in the form of 4-pipe fan coil units. Fan coil units must be provided with cooling and heating coils, each with 5/8" copper tubes and aluminum fins spaced at a maximum 12 fins/inch. Chilled water coil design must be based on 38° F entering water temperature and 62° F leaving water temperature. Heating water coil design will be based on 180°F entering water temperature and 120°F leaving water temperature. Face velocities below 480 FPM are recommended and values above 500 FPM are prohibited. All units must be equipped with filters. All filters must be high efficiency, low pressure drop filters. All units up to 5,000 CFM must have 2" disposable filters. Fan motors must be EPAct Premium Efficiency. Fan coil units must be manufactured by Temtrol, Carrier, Trane, or Johnson

Controls/York. The supplemental air handling unit controls will be integrated into and compatible with the existing terminal (DDC) system. Fan coil units above 2000 CFM must be interconnected into building fire alarm system, in accordance with DFW Guidelines and AHJ.

10. Building exhaust. No building exhaust will be provided in the tenant spaces. The tenant must provide all necessary exhaust systems, including hoods, rated shafts, and rooftop equipment, to meet the space requirements. Food and beverage spaces with exhaust hoods must maintain a negative pressure as referenced to the terminal (approximately -0.05" w.g.). Tenant must label and provide an absorbent grease pad at all hoods, rooftop equipment and vents. Tenant must also provide an O&M manual for the maintenance of that equipment. **(Also Reference Section 3.11, "Roof Penetrations.")**
11. Air balance tests are required to verify the installation of the designed system CFM is sufficient and accurate. The test results are required prior to TCO issuance.

3.8.1.1 Concession Spaces Control Requirements

Provide dedicated BACnet (BTL) listed control panel serving the concession space. The concession space shall interface with the Terminal Building Automation System via BACnet/IP connection (to data port located in tenant space).

The control panel and associated application specific controllers (ASC) shall be Manufactured by one of the following:

1. Honeywell WEBs-AX
2. JCI Metasys
3. Schneider I/A Series
4. Siemens Apogee
5. Trane Tracer

The following are minimum controls needed to interface with Terminal Building Automation System:

Terminal Boxes (VAV boxes and fan powered terminal units) connected to building HVAC system shall include the following:

- Space or zone temperature
- Terminal box set point temperature
- Terminal box primary airflow (CFM)
- Terminal box supply air temperature

Supplemental HVAC equipment connected to building chilled water and heating water:

- Space or zone temperature
- Supplementary equipment set point temperature
- Supplementary equipment supply air temperature

Concession space:

- Chilled water return temperature (if connected to chilled water system)
- Heated water return temperature

3.8.1.2 Vent Hood Requirements

Every cooking appliance in a commercial cooking operation is required to be located under a kitchen exhaust hood to capture and remove cooking effluents such as smoke, grease-laden air, moisture, excess heat and odors. Cooking appliances are used for commercial purposes when such appliances are primarily intended for the preparation of food for compensation, trade or services rendered. The term "grease" refers to animal and vegetable fats and oils that are used to cook foods or that are a byproduct of the cooking process, such as the grease rendered during the cooking of bacon and other meats. Type I Commercial Kitchen Hoods are required over light duty commercial cooking appliances that produce grease or smoke; over medium duty commercial cooking appliances; over heavy duty commercial cooking appliances; and over extra heavy duty commercial cooking appliances.

Furthermore, Looking at the 2009 Code there has been a change for the Type II hood requirements from the language in the 2006, to include a definition of "Light duty cooking appliance". These 2009 code changes will allow for much more flexibility.

In general, it appears that all of the light duty cooking appliances, as defined in the IMC, that **do not** produce grease vapors or smoke will be allowed to be installed within the Terminal buildings without Type II hoods with the following conditions.

1. Provide the menu items that will be cooked to show very little, or no smoke or grease vapor being released.
2. A mechanical engineer, familiar with the HVAC systems within the terminal, shall provide a stamped and signed letter with supporting documentation to show the HVAC system is fully capable of removing **ALL** heat and moisture released by all light duty cooking appliances installed.
3. Or, a separate HVAC system shall be installed to accommodate this heat and moisture vapor.
4. Mechanical fresh air shall be provided in accordance with 403.3, with each appliance installed being provided not less than the fresh air

required for 100 sq. ft. of floor space. This will be part of the documentation provided by items #2 or #3 above.

5. A Type II hood **shall** be installed over light duty cooking appliances that have products of combustion (**Gas fueled appliances**).

As the newer remodeled areas of the Terminals come on line, meeting item #2 should be relatively easy, the terminal sections not yet remodeled may require extensive work on the HVAC systems to meet the above criteria.

It appears that the appliance cut sheet provided for standard "Turbo-Chef type warming ovens" will meet the definition of a "light duty cooking appliance" when operated and maintained in accordance with the manufacturers guidelines and safety standards. The building official, as the authority having jurisdiction, has interpreted these provisions to be in compliance with the intent and purpose of the adopted codes. Also, having final jurisdiction, the building official may enforce stricter requirements; whereas it is determined that the aforementioned appliances are-not or have-not been properly utilized and/or maintained. Any fire and life safety issues that arise or violations of the International Fire Code will be enforced by the Fire Marshal's Office. The extent of additional enforcement will be at the discretion of the Fire Marshal and are the sole resultant consequence of the tenants' procedures. Maintenance of the units is the sole responsibility of the concessionaire/operator and an annual inspection by the Fire Inspectors will take place at every location. These annual inspections may give cause for the Fire Marshal to make a determination that a hazard exists if maintenance and/or use of the unit is not acceptable.

Any further determinations and/or enforcements and required upgrades to the location or its equipment will be solely at the expense of the tenant as discovered by the Building Code Official. The location may temporarily be barred from operations until any and all deficiencies are corrected and cleared for operations by the Fire Marshal's Office. **(Refer to Section 11.4 DFW International Airport ETAM Department Vent/Hood Data Form.)**

3.8.2 Electrical

Terminal A is defined in **Section 7**, Terminal B is defined in **Section 8**, Terminal C is defined in **Section 9** and Terminal E is defined in **Section 10**.

The tenant is responsible for the engineering design and installation of a complete and functional electrical service for the lease space, meeting all applicable codes. Panels and step-down transformers are to be located within the lease space, unless otherwise approved in writing by the TPM. Service voltage will be 277/480v, 3-phase.

Each lease space is provided with an empty conduit with pull string from a 277/480V 3-phase distribution panel. The size of the conduit is indicated on the "Utility Assumption Matrix." The location of the referenced conduit will be

shown on the drawings or reference. Tenant to field verify exact location and existing conditions. **(Reference Sections 7.1, 8.1, 9.1 or 10.1, "Provisions Summary", Sections 7.2, 8.2, 9.2 or 10.2, "Responsibility Matrix", and Sections 7.3, 8.3, 9.3 and 10.3, "Concessions Service Matrix")**

3.8.3 Plumbing

Terminal A is defined in **Section 7**, Terminal B is defined in **Section 8**, Terminal C is defined in **Section 9** and Terminal E is defined in **Section 10**.

DFW will provide a capped potable water connection below the concourse floor or above the ceiling at the lease line where applicable. Domestic hot water is the tenant's responsibility. The tenant is responsible for the engineering design and installation of a complete and functional plumbing system for the lease space. They are also responsible for the labeling of all plumbing lines. New construction and remodeling projects must include all new plumbing lines.

All sanitary, vent, grease waste, and cold water piping must connect to existing lines in the immediate tenant area/closest feasible connection location and be furnished and installed by the tenant. DFW will provide a sanitary vent line connection in the ceiling space of the concession. **(Reference Sections 7.1, 8.1, 9.1 or 10.1, "Provisions Summary", Sections 7.2, 8.2, 9.2 or 10.2, "Responsibility Matrix", and Sections 7.3, 8.3, 9.3 and 10.3, "Concessions Service Matrix")**

If a tenant needs to incorporate a ventilation riser, the locations of shafts, roof penetrations, etc. must be coordinated with DFW during the design of the concessions space. **(Reference Sections 3.11, "Roof Penetrations.")**

Sanitary service lines will be provided to the perimeter of applicable lease spaces, **(Reference Sections 7.2, 8.2, 9.2 or 10.2, "Responsibility Matrix", and Sections 7.3, 8.3, 9.3 and 10.3, "Concessions Service Matrix")** at the wall closest to the main drainage line beneath the concrete floor of the concourse level. Tenant shall extend sanitary service through the slab and into the leasehold. All sanitary piping shall be heat traced to the tenants lease line. The heat trace will need to be the same manufacturer as the existing and installed per the manufacturer's recommendation and must maintain 110°F temperature. Tenant shall provide all necessary splice kits, etc. for a fully working system. All heat trace shall be insulated and have metal jacketing for all exposed and exterior spaces. "Remove Me Not" strainers, or equal, must be in place on all floor drains and recessed floor sinks.

Grease waste lines will be provided to the perimeter of applicable lease spaces **(Reference Sections 7.2, 8.2, 9.2 or 10.2, "Responsibility Matrix", and Sections 7.3, 8.3, 9.3 and 10.3, "Concessions Service Matrix")** at the wall closest to the main drainage line beneath the concrete floor of the Concourse level. For kitchen/food service areas, design professional must consult local AHJ to determine segregation of tenant drainage connections between grease waste lines and sanitary lines. Tenant is required to extend DFW heat trace on all new

grease lines from tenant's connection to the Terminal grease waste lines to the fixture within tenant lease space. The heat trace must be the same manufacturer of the existing and be installed per the manufacturer's recommendation to maintain 110°F temperature. Tenant will provide all necessary splice kits, etc. for a fully working system. All heat trace must be insulated and have metal jacketing for all exposed and exterior spaces.

Tenant will install a Continuous Enzyme Treatment System as outlined below:

1. The tenant shall provide and install a complete Enzyme Treatment System on all Grease Waste Drains located within the lease space. The tenant is responsible for supplying all materials, to include but not limited to, plumbing, electrical and mounting hardware. The following type of Enzyme equipment shall be installed on all Grease Waste Drains:
2. Full Grease Eradication Systems by Environmental Plumbing Systems (EPS), Chemsearch and/or OWNER'S APPROVED EQUIVALENT
3. The tenant shall provide a microbial growth system which automatically discharges/dispenses active bacteria into the grease waste system stream over a 24 hour period by means of a programmable unit.
4. The tenant shall control the dosing at each location and shall ensure that the dosing levels meet the performance standards at all times.

It is prohibited to use any compressor-fed refrigeration system. All refrigeration units must be connected to the terminal chilled water system. Additional requirements are available through TPM. (**Reference Sections 7.1, 8.1, 9.1 or 10.1, "Provisions Summary", Sections 7.2, 8.2, 9.2 or 10.2, "Responsibility Matrix", and Sections 7.3, 8.3, 9.3 and 10.3, "Concessions Service Matrix"**)

Tenant is required to contract with a plumbing contractor who has recent (within the previous 5 years) experience with DFW International Airport for all plumbing work that connects to existing terminal systems, unless otherwise approved by DFW Concessions.

3.8.4 Natural Gas/Liquid Propane Gas

Natural gas is available for tenant use. Propane or bottled cooking gas is prohibited. Gas pipe located in a wall, under a floor or outside of the tenant space must be welded, painted appropriate color and labeled with flow direction, pressure and tenant location being serviced. Tenants using gas appliances must provide a gas detection device connected to the fire alarm as required by the Fire Marshalls office. Gas appliances must have electric pilot starters.

3.9 Fire Protection and Life Safety

The tenant is responsible for designing and performing all work in accordance with, and installing all fire protection and life safety features required by the DFW International Airport Construction and Fire Prevention Resolution and Amendments and adopted Fire Code. Tenants should refer to the overall final version of the fire protection plan and applicable specifications and system drawings for additional information or detailed requirements of the systems.

The tenant will provide the engineering design, modification and installation of the fire sprinkler and alarm system, which must comply with design standards prepared for the terminal. In general, the fire protection system should include:

1. The design, modification, and installation of wet-pipe fire sprinkler systems.
2. The design, modification, and installation of new and/or existing fire sprinkler heads for lease space layout.
3. The design and installation of adequate fire protection systems for kitchen equipment as required.

The kitchen hood fire protection systems must be connected to the building fire alarm system, for supervision only.

If the tenant adds supplemental air handling units to the lease space, the tenant must install duct-mounted smoke detectors (where required) on the supplemental air handling units. The duct smoke detectors must be connected to the building's fire alarm system. If the supplemental air handling unit has a design capacity over 2000 CFM, smoke detectors must be installed in the air handling unit or the space served by the supplemental air handling unit must be protected by area smoke detectors connected to the building fire alarm system.

Section 3.9.2 ("Fire Alarm") provides details of the fire alarm and voice communication system.

Lease spaces are not independent fire protection zones. Fire protection zones are based on column locations, and several leases may be in the same fire protection zone.

The tenant is responsible for maintaining fire rated partitions and penetrations, walls, roofs, floors and ceilings along tenant lease lines.

3.9.1 Smoke Control

3.9.2 Automatic Smoke Control Systems

The base building will provide a networked, fully addressable fire alarm and voice evacuation system tied in to the terminal master system. The voice evacuation system uses a combination of speakers from the buildings IED paging system, and visual notification (strokes) from the building's fire alarm system

operating as one system. The speaker and strobe coverage must be in accordance with NFPA 72 and the DFW Design Criteria Manual.

The tenant contractor is responsible for installing required new devices and modifying the location of existing devices, wiring, conduit and other required features within their lease space. All connections to the building's fire alarm system are to be coordinated through the DFW Fire Marshal's office and ITS Life Safety personnel and will be handled on a case-by-case basis through the DFW Fire Marshal. The same fire alarm vendor/installer used for the base system must be used (Honeywell). The fire alarm devices must be compatible with the base system and installed on the base system loops.

Initiating devices will be zoned to correspond with automatic sprinkler and fire alarm.

The tenant is responsible for locating speakers and visual notification devices (strokes) as required by the current edition of the International Fire Code and NFPA standards at their storefront and inside the lease space. Speakers and visual notification devices cannot be mounted to the Neutral Frames or to the tenant storefront glazing. Note that horn and horn/strokes will not work in Mass Notification Events.

In addition, tenant sound systems including televisions must mute upon command of the building fire alarm system so that voice evacuation or other egress messages are intelligible.

(Refer to 3.7.3, "Public Address System" for further definition regarding electro acoustic requirements.)

Kitchen hood suppression systems must be connected to the building fire alarm system by the base system fire alarm vendor/installer and installed on the base system's loop.

3.9.3 Automatic Sprinklers

Sprinklers should be installed based on current building codes for the tenant's occupancy class but no less than 0.15 gpm/s.f. over 1,500 s.f. and a maximum spacing of 130 s.f./sprinkler. The sprinkler system must be coordinated with the main system.

The existing airport fire sprinkler system must be supplemented by tenant to comply with code classification for its occupancy and adjacency.

3.9.4 Strobes and Speakers

The tenant is responsible for complying with Fire Protection and Life Safety requirements as related to strobe and speaker locations at their storefront and inside the lease space. Strobe lights and speakers cannot be mounted to the Neutral Frames or to the storefront glazing. The speakers are connected to the

terminal's IED Paging System. The strobes are connected to the terminal's fire alarm system. The strobes must be compatible and synchronized with the strobes throughout the terminal and be labeled "ALERT."

3.9.5 Emergency Lighting

Emergency lighting and exit signage are required throughout the terminal and tenant spaces in accordance with the current adopted edition of the International Building Code. Tenant must provide battery packs for required exit sign(s) and egress lighting. Shell space emergency lighting and exit sign(s) must be returned to airport and conduit demolished back to j-box within the space. Additionally, emergency and stand-by power will be provided for all fire and life safety systems, per the current adopted edition of the International Building Code.

3.9.6 Means of Egress

The occupant load for tenant spaces, and the required number and location of exits should be determined by using current and applicable building codes. Occupant load calculations and egress plan will be required with the Schematic Design submittal-35%. Occupant load calculations and an egress plan (showing egress to Airport egress point) will also be required. **(Reference Section 5.1.1, "Schematic Design Submittal – 35% Review.")**

3.9.7 Interior Finishes

Interior finishes must meet all applicable flame spread ratings as prescribed in the current codes adopted by DFW International Airport.

3.10 Telephone / Data

Concessions spaces will be provided with a communications service pathway (empty conduit with pull string and / or cable tray) and a service demark panel located within each concession space for DFW usage only. The service demark panel is the property of DFW and must not be altered by the tenant. Each tenant will be responsible for procuring Phone/Data/CATV service, including connectivity infrastructure and installation, as required, through the DFW ITS managed service provider.

Provisions Summary:

Base Building: Service demark panel (Tenant Panel) in tenant space, with empty conduit/cable tray pathway to nearest service provider distribution location (Distribution Panel).

Tenant Improvements; Media wiring from Tenant Panel to service provider Distribution Panel, service equipment, end devices, and device wiring within tenant lease space.

3.11 Roof Penetrations

Roof penetrations are only allowed in specific R.O.W. zones (determined by the DFW team) and must be approved by DFW. The tenant's design team must submit all appropriate roofing penetrations during the design process for review and approval by the Roof Manager, DFW Asset Management Department.

The tenant is responsible for all roof penetrations, roof mounted equipment and pathways to roof penetrations from the tenant lease line. Because of existing conditions there will be challenges in getting exhaust, venting and air intake from the lease lines to the roof. However, it is possible to get all venting, exhaust and air intake requirements to the roof without major disruptions to spaces above. The tenant will be required to use methods of best practice to determine appropriate and logical right of ways for all necessary roof penetrations. The tenant will be responsible for coordinating pathways with DFW, AA (Terminals A & C), American Eagle (Terminal B), O.A.L.'s (Terminal E) and the appropriate facility groups affected by the tenant's concession design. The tenant is encouraged to use in their design existing shafts and pathways to existing roof penetrations that exist as a result of the previous work performed. Any existing shafts and roof penetrations within the tenant lease line not used in the tenant's new design must meet all applicable building codes and will be the responsibility of the tenant.

The tenant will be responsible for meeting all fire ratings as required by DFW and applicable building codes.

Any roof related work such as roof penetrations, roof curbs, flashing and roof membranes must be submitted to and approved by the roof manager with the DFW Asset Management Department and should not void existing roof warranties. All roof mounted equipment must meet the DFW design guidelines and all applicable building codes as a minimum requirement.

Exhaust fans must be designed and placed with the appropriate distances between existing structures and other equipment to avoid the spread of exhaust odors and recirculation of exhausted air. All grease exhaust must be of proper design including drip pans when necessary to eliminate grease residue on the roof. The tenant will be responsible for any and all damage related to the installation of new roof penetrations and roof mounted equipment.

3.12 Structural Loads

Tenants are limited to the following superimposed loads:

- 10 psf flooring
- 10 psf ceiling + collateral dead loads
- 100 psf floor live load

Loads in excess of these values must be substantiated by calculations.

4.0 RESPONSIBILITIES AND PROCEDURES

4.1 Codes and Standards

Tenant Project Planner (TPM) assists in the various steps of the application/review/construction process and reviews the application for compliance with this Manual. Tenants will select architects and general contractors who will submit applications to the DFW Concessions Department, the governing health agency (if food and beverage are involved), and the DFW Airport Concessions Department. (**Reference Section 5.0, “Design Review and Code Submittal”**)

4.1.1 Professional Responsibility Statement

All facilities located within the boundaries of the Airport must be designed by a practicing professional architect and/or engineer licensed in the State of Texas. The professional must sign and seal the work, which must be confined to the profession in which he/she is licensed.

4.1.2 Applicable Building Codes

Tenant design and construction must comply with applicable federal, state, and local laws, statutes, orders, codes, ordinances, and regulations that are legally applicable to the work to be performed. The DFW Airport Board and the cities of Dallas and Fort Worth have adopted the DFW Construction and Fire Prevention Standards Resolution and Amendments to the adopted Fire Code for all construction within the boundaries of the Airport.

4.1.3 Health Department License and Permit

Any establishment providing potentially hazardous food, or open food, to the public is required to have a permit and be inspected for compliance with the **Texas Food Establishment Regulations**. Tarrant County permits and inspects DFW International Airport. Tenant is responsible for making required submittals to the appropriate agencies. For Tarrant County review, one set of plans is to be sent to:

Tarrant County Public Health Department
1101 S. Main Street
Fort Worth, Texas 76104
817-321-4960

4.1.4 Sustainability

In keeping with the Airport's sustainability commitment, concession tenants shall employ green design strategies wherever possible, and follow criteria outlined in the DFW International Airport Green Building Standards (GBS). This document may be obtained at www.dfwairport.com.

Specific sustainable strategies include but are not limited to:

- Use of recycled and locally sourced materials (**Reference section 3.1.5, "Interior Walls and Doors"**)
- Maximizing the use of daylight to limit energy consumption.
- Water use reduction through more efficient appliances, fixtures and fittings.
- Reduce, reuse, recycle and salvage of construction waste.
- Use of energy efficient appliances, lighting, and HVAC systems
- All appliances and equipment must be Energy Efficient as qualified by the EPA's ENERGY STAR Program.
- Connect refrigeration units to the airports sustainable chilled water system
- Submit energy efficient lighting calculation forms to the code dept.
- Required Use of zero VOC (Volatile Organic Compound) emitting materials in furniture, adhesives, sealants, paints, coatings and composite products.
- Required use of materials using no urea formaldehyde
- Wood products should be wood certified in accordance with the Forest Stewardship Council's principles and criteria.

Compliance with LEED certification through the U.S. Green Building Council (USGBC) is optional. If seeking LEED for Commercial Interiors certification, please note that design features of the existing terminal renovation may provide credits toward certification, including:

- Development Density and Community Connectivity.
- Alternative Transportation: Public Transportation Access.

Please reference www.usgbc.org for additional information regarding the LEED for Retail: Commercial Interiors rating system.

4.1.5 Accessibility Standards

All facilities must be designed and constructed in compliance with current Americans with Disabilities Act Accessibility Guidelines (ADAAG) and with Texas Accessibility Standards (TAS) guidelines. The tenant is responsible for making required submittals to the appropriate agencies. (**Reference DFW Design Criteria Manual, www.license.state.tx.us/AB/tas/abtas.htm, and www.ada.gov**)

If your project's total estimated construction cost is less than \$50,000, you are not required to submit the project to Texas Department of Licensing and Regulation (TDLR) for registration and review, **however**, the project is still required to comply with TAS. Projects with costs of \$50,000 or more are required to submit a full set of construction documents and applicable fees.

Registration/review procedure: When construction documents are complete and prior to submittal for building permit, the project must be registered with TDLR. Registration forms and online registration can be found at:

www.license.state.tx.us/ABProjectRegistrationOnline

The tenant is responsible for ensuring that the Project Registration Confirmation Page, construction documents, and applicable fees are mailed, shipped, or hand delivered to the **TDLR or a Registered Accessibility Specialist (RAS)** for the required review and inspection of the project within the TDLR required time limit. A RAS is a registered professional licensed by the state of Texas to provide TAS reviews and inspections.

Within 30 days of construction completion, the tenant is required to have the premises inspected by a RAS and resolve any non-compliant issues that may be found.

4.1.6 DFW Design Criteria Manual

All tenants, architects, engineers, and contractors must be familiar with the DFW Concessions Tenant Design Manual as well as with the applicable sections of the current edition of the DFW Design Criteria Manual and adopted Airport codes. **(Reference www.dfwairport.com as amended)**

The Code Enforcement Section of the Airport Design, Code & Construction Department (DCC) publishes the DFW Design Criteria Manual. The purpose is to inform architects and engineers of acceptable design parameters for the design of construction improvements within the boundaries of the Airport. The TPM can assist tenants, architects, and contractors in securing this document.

While the DFW Design Criteria Manual refers to legally binding codes and standards that have been adopted by the Airport, it is not in itself a code, standard, or specification, but rather a guide for the tenant's design consultants. The Design Criteria Manual must NOT be referred to in construction documents. Such notations as, for example, "Construct in accordance with DFW Design Criteria Manual" are not permitted. Conflicts between the DFW Design Criteria Manual and this Manual should be addressed with the TPM.

5.0 DESIGN REVIEW AND CODE SUBMITTAL

Terminal A is defined in **Section 7**, Terminal B is defined in **Section 8**, Terminal C is defined in **Section 9** and Terminal E is defined in **Section 10**.

The tenant is responsible to attend a pre-design meeting with the TPM within fifteen (15) days of Board approval / or being notified by the Concessions Department. At the pre-design meeting the TPM will review the tenant's lease exhibit applicable to his/her particular space, and any interim design modifications regarding this Manual. Working from this information, the tenant develops the plans and specifications required for the design review and the tenant construction application, and ultimately for construction. **(Reference Section 6.0, "Construction.")** All tenant improvements are subject to the approval of the TPM and the DFW Code Enforcement Department. Tenants must submit construction applications for each project. Plans must be submitted in three phases: schematic design, contract documents, and permit documents. The construction application form must be completed and included with the code submission.

The tenant and the tenant's architect and/or engineer must refer to the TDM to determine when signed and sealed documents are required. The tenant and the tenant's design team must also comply with the DFW/CDP CADD standards for electronic drawing set up and to determine when electronic drawings are required. **(Reference DFW Design Criteria Manual, DFW CADD Standards Manual.)** Variances, if any, to the criteria may be approved on a case-by-case basis. Such approval must not be construed to apply to any other case; variances must be identified and requested in each submittal.

Deviations between the criteria drawings in this Manual and the Airport's lease exhibit should be addressed with the TPM.

Before commencement of construction, the tenant or the tenant's design professional must make on-site inspections of the leased premises. The purpose is to verify the as-built location, conditions, and physical dimensions of the leased premises, and to assure that the final contract documents conform to them. Failure to do so will be at the sole risk and expense of the tenant.

DFW Airport concessions department does not inspect the drawings for coordination between MEP and architectural disciplines. The DFW Code Department will inspect the drawings based on their respective disciplines and the comments issued will be based on the information depicted only in the documents related to that discipline. It is the job of the project design team to ensure the completeness of the coordinated set of design documents. It is the sole responsibility of the concessionaire's team to ensure that all critical information, elements and dimensions are depicted accurately and that all information critical to applicable codes are submitted to the appropriate authority having jurisdiction.

All submittals to the TPM must include the Lease Space Reference Number (For example: A-2-111-A01).

5.1.1 Schematic Design Submittal – 35% Review

Schematic design drawings must be submitted and, as a minimum, must include the following:

1. A key plan showing the location of the lease space within the terminal.
2. Preliminary floor plan, reflected ceiling plan, and demolition plan (minimum $\frac{1}{4}'' = 1'-0''$) indicating interior design concept.
3. Typical interior elevations (minimum $\frac{1}{4}'' = 1'-0''$).
4. Storefront elevation and section, including any graphics and signage and indicating all materials and finishes (minimum $\frac{1}{2}'' = 1'-0''$).
5. Interior and exterior colored renderings.
6. Preliminary sign details, digital menu boards and graphics, (minimum $1\frac{1}{2}'' = 1'-0''$).
7. A preliminary finish schedule.
8. Utility connection drawings, including riser diagrams and load summary schedules (**Reference Section 11.1 Heat Loss Schedule, Section 11.2 Heat Gain Schedule and Section 11.3 Electrical Review Schedule**).
9. Preliminary single-line schematic drawings of mechanical/electrical/plumbing (MEP) connections and locations.
10. A preliminary project schedule.
11. Health Department application forms (food and beverage tenants only).
12. Sample boards with material and color selections, 11" x 17" only.
13. Railing designs for applicable spaces.
14. Occupant load calculations and egress plan showing egress to outside of the terminal.
15. Dimensioned location for the blade sign.
16. Dimensioned location of the Tenant Demark Panel (Black Box) on an existing wall.
17. BDDD Preliminary Sub-Consulting Form for Design Phase.

When initial review is completed, the TPM will issue written response of acknowledgement before work may proceed on the contract documents.

5.1.2 Contract Documents Submittal – 95% Review

This phase should include construction documents as follows:

1. A key plan showing the location of concessionaire within the terminal, and include a construction access plan.
2. Floor plans (minimum $\frac{1}{4}'' = 1'-0''$) indicating storefront construction materials, colors, and finishes; security grille location (if required); location

- of partitions and type of construction; and locations of any tenant-provided toilet rooms, indicating placement of plumbing fixtures.
3. Reflected ceiling plans (minimum ¼" = 1'-0") indicating ceiling materials and conditions; ceiling heights; location of all light fixtures, manufacturer's name and catalog number, lamps to be used, and mounting (recessed, surface, etc.); location of sprinkler heads; location of HVAC grilles; and location of plenum access panels.
 4. Storefront elevation and section (minimum ½" = 1'-0").
 5. Typical interior elevations (minimum ¼" = 1'-0").
 6. Interior finishes schedule, and illustration boards (maximum 11" x 17") with clearly labeled and firmly attached samples and color chips.
 7. Detailed signage drawings and details (minimum 1½" = 1'-0") indicating elevation and section views, letter style and size, all colors and materials, methods of illumination, color of illuminate, and voltage requirements. Food tenants must include digital menu board details as well as any proposed method of temporary signage (sales, daily or weekly specials) including location, size, materials, color, letter type, and framing method.
 8. Mechanical drawings, including electrical, HVAC, plumbing and sprinkler, and load summaries. Drawings must indicate placement of all MEP equipment, connected electrical loads, and weights of heavy equipment, cases, etc.
 9. Utility connections for water, sewer, electrical, telephone, and lighting; building mechanical, plumbing, electrical, lighting, fire protection, fire alarm plans to scale; detailed riser diagrams; and load schedules. **(Reference Section 11.1 Heat Loss Schedule, Section 11.2 Heat Gain Schedule and Section 11.3 Electrical Review Schedule).**
 10. Project Construction Schedule.
 11. Temporary construction barrier partition plan (minimum ¼" = 1'-0"), and partition elevation (minimum ¼" = 1'-0") with proposed "Coming Soon" graphics. Per Tenant Design Manual.
 12. All signage and millwork to meet applicable codes and standards set forth in the Design Criteria Manual.
 13. Detailed signage shop drawings will be submitted and approved by the TPM prior to fabrication.
 14. Final interior and exterior color renderings. (Rendering must be updated with any design or material changes.)
 15. Architects' and MEP statement of site visitation.
 16. Capital investment cost estimates on new construction or remodeling.

Specifications should be submitted on drawings.

The documents at this point should contain all the revisions requested prior to this submittal. Upon submittal review completion, the TPM will issue written review comments for inclusion into the permit documents submittal.

5.1.3 Permit Documents Submittal

All documents are to be submitted electronically to the TPM. Once ALL documents have been received, the TPM will submit them to the DFW Code Department.

The permit documents submittal to the TPM for DFW Code Department review shall consist of the following (see TPM for any revised or updated checklists):

Submit documents sufficient to demonstrate compliance with the applicable Building Codes, Criteria Manuals, and this Manual. All documents to reference the construction application (permit) number and the lease space reference number.

1. All signage and millwork to meet applicable codes and standards set forth in the Design Criteria Manual.

The concessions department requires the following documents:

1. Construction Application – **Application must be sign by the Tenant.** Form can be found on dfwairport.com.
2. Copy of Executed Contract (If GC has not been selected at time of submittal to Code; provide on company letterhead the anticipated contract amount and base fees on that amount. Final Executed Contract is due prior to Pre-Construction meeting; this will be how the permit fees are calculated.)
3. Copy of TDLR Submittal Form
4. Proof of TDLR Plan Review and Inspection fee paid
5. Copy of completed TDLR Review
6. PDF of Construction Documents (CD's). If file is too large send drop off CD or thumb drive to Concession TPM. (Must include Floor Plans with Seating, Décor Packages, Egress Plans, etc. and specifications.)
7. Copy of Menu (F & B only)
8. Proof of Submittal to Tarrant County Health (F&B only)
9. BDDD Schedule of Subcontractors for Design – Final.
10. Architect and MEP Verification of Site Visit (Written on your company letterhead)
11. Schedule-Anticipated (Hard Copy)
12. 1 half size set of CD's for Concession (11 x 17)
13. CADD Files (Will be integrated into TRIP BIM model for TRIP projects only.)

Environmental Requirements-Once the GC is selected, call Deena Henry with EAD, 972-973-5569 to schedule a meeting (while project is in Codes) forms list below will be completed and reviewed during that meeting.

1. Waste Management Plan
2. Spill Contingency Plan
3. Copy of Asbestos Survey

5.1.4 Code Review Process

A minimum of two weeks should be allowed each submittal for review and approval. Review time will vary, depending on the project's size, complexity, whether the approval of an outside agency is necessary, and the number of projects being reviewed at one time. In the event changes or modifications to the submitted material are required, conditional approval may be given, contingent upon ultimate satisfaction of the changes noted. All permitting comments can be found via web at:

<http://extapps.dfwairport.com/impactwebclients/permits/Permitting.aspx>.

When all comments have been received, the tenant applicant will be notified that the permit is ready and the amount of fees which are to be paid. The contractor may then schedule a preconstruction meeting.

Revisions made after the approval of documents and during construction must be coordinated and approved by the DFW Code/TPM before their installation.

Before the Certificate of Occupancy will be issued, the tenant must provide the DFW Code Department with a complete set of as-built record documents in DFW Code Department required format, the completed environmental checklist that is attached to the construction permit and copies of air balance test reports, and also provide a copy of as-built record documents on CD in CADD and PDF format to DFW Concessions Department.

5.2 Tenant Lease Space Return Policy

If the tenant discontinues their lease or decides to relocate to a different leasehold within the airport terminal, the tenant is required, prior to vacating, to return the leasehold back to the original condition at pre-construction walk-through. Any equipment permanently mounted to the terminal building remains the property of DFW airport. The tenant is required to return all storefront aesthetics back to the Neutral Frame and provide an infill panel as specified by the airport. This panel must have an access door situated near the Neutral Frame with a cipher lock installed on the door.

5.3 Maintenance of Building Systems

Generally, maintenance of all tenant-installed and/or modified utilities and building systems within the lease space is the responsibility of the tenant. However, the Airport retains the right to maintain certain utilities/systems even

within the tenant lease space. Refer to lease document for a list of Airport-maintained items. Tenant must provide O&M manuals.

6.0 CONSTRUCTION

6.1 Procedures

These construction procedures are intended to allow flexibility and accessibility to the tenant's contractor for the timely execution of the tenant's work.

6.1.1 Temporary Provisions (where applicable, see TPM for exceptions)

1. The tenant is to provide and maintain temporary dust partitions to seal openings to all adjacent areas.
2. Temporary construction partitions must be located a maximum of 3'-0" beyond the tenant's furthest projection, see TPM for exceptions.
3. Sound Attenuation in the temp. wall is required for daytime work.
4. Partitions must extend the full height to the existing ceiling to positively seal off the construction area. All temporary partitions must be self-supporting. "Coming Soon" graphics are required and must be approved by DFW Concessions. The graphic is to cover at least 75% of the wall surface.
 - a) Barricade graphics may contain the brand name, brand art work, or imagery and design renderings.
 - b) Advertisements, requests and petitions of any kind are prohibited.
 - c) Names of operators, contractors, or design firms are prohibited.
5. Building finishes will not be disturbed or altered in the construction of this partition. Temporary partitions may not be anchored to the ceiling or terminal floor.
6. All existing and adjacent finishes and flooring are to be returned to their original condition when temporary partitions are removed.
7. Access doors into construction areas must be solid core or hollow metal doors with commercial grade hardware and must be mounted in metal frames. A cipher lock (keypad lock, steel 11 button--Grainger # 1RAJ5) is to be installed on the access door to allow the tenants and emergency personnel access to the space during construction.
8. Plans and Elevations for the partition are to be submitted with the construction document submittal. **(Reference Section 5.1.2, "Contract Documents Submittal – 95% Review.")**
9. Water from drilling or cutting operations must be controlled. Surfaces below such operations must be protected. The tenant is responsible for the costs of any damages sustained in such procedures.

6.1.2 Security

The tenant is entirely responsible for the security of the leased premises during construction, and must take all necessary steps to maintain Airport security. The most current Airport security requirements are available through the TPM. The

Airport will have no liability for loss or theft of any property. **All contractors and subcontractors will be required to follow all Access Control Office procedures. Information for badge applications may be found at www.dfwairport.com. The DFW Access Control Office can be contacted at 972.973.5100**

6.1.3 Construction and Coordination

The tenant's contractor is to keep all terminal areas and access points outside of lease space free of construction materials, tools, and debris at all times.

The tenant must submit, in writing, a construction phasing and operations plan to include a construction schedule containing all significant construction activities and milestones to the TPM for review and approval. The plan is submitted with the Permit Documents and is reviewed at the preconstruction conference preceding the commencement of construction. **(Reference DFW Design Criteria Manual and Section 5.1.3, "Permit Documents Submittal.")**

Contractors for the concession tenants must coordinate their construction activities with the terminal contractor through the TPM.

Project construction coordination includes, but is not limited to, the following issues:

1. Site and terminal access and site safety.
2. Maintenance of the Federal Aviation Administration (FAA) security requirements.
3. Maintenance of both terminal and tenant leasehold construction site security.
4. Materials delivery and storage.
5. Employee parking.
6. Trash removal and construction site cleanup.
7. Hours and days construction allowed, i.e., coordination of terminal and tenant lease space construction schedules.
8. Connections to and modifications of Terminal Fire Protection and Life Safety Systems.
9. Modifications to terminal structure.
10. Code Enforcement Inspections.
11. Systems testing; include air balance testing.
12. Project close-out and Certificate of Occupancy inspections, etc.
13. Ventilation and exhaust ducting needs.
14. Code approved Drawings must be onsite as well as a copy of the Approved renderings, the ACM survey, construction schedule, a 2 week look ahead plan, safety/emergency contacts and a sprinkler shunt gun.
14. Tool Safety Plan **(Reference <http://connected.dfwairport.com/dps/index.php> for requirements.)**

6.1.4 Base Building Finishes

Tenants are required to restore all disturbed base building finishes resulting from their construction. The tenant is required to match adjacent building finish floor material if the existing finish has been damaged or discolored during construction. The tenant should schedule, with the TPM, a preconstruction inspection to document the state of adjacent finishes.

7.0 EXHIBITS TERMINAL A

7.1 Provisions Summary- Terminal A

NOTE: Conditions listed below may not apply to all lease spaces. Refer to DFW Airport Provided Responsibility Matrix in section 7.2.

	Base Building	Tenant Improvements
STOREFRONT	Curtain wall side panels flanking neutral frame. Multi-bay tenants may elect to remove this DFW provided storefront from center column location. A formal request for deletion must be forwarded to DFW Concessions Department in writing prior to initial design submittal.	Build-out by tenant inside of neutral frame opening in accordance with the DFW Concessions Tenant Manual.
NEUTRAL FRAME	Consistent metal frame surround defining each storefront opening.	3/4" black reveal separating neutral frame from any tenant designed store elements.
DEMISING WALLS (TYPE 1) (All demising walls shown on Lease Exhibits are type 1 U.O.N.)	Refer to Lease Exhibits	Gypsum wallboard, insulation and finishes.
DEMISING WALL (TYPE 2)	Refer to Lease Exhibits	Gypsum wallboard, insulation and finishes. 20% of Type 2 demising walls can be translucent or open but cannot be open for pass-through circulation.
CEILINGS	Exposed structure.	By tenant to approved design criteria.
ACCOUSTICAL SOUND TRANSMISSION PROTECTION		In accordance with the DFW Concessions Tenant Manual.
FLOORS (TENANT INTERIOR)	Existing exposed concrete	Floor finishes in accordance with DFW Concessions Tenant Manual.
FLOORS (PUBLIC SEATING)	Terrazzo	Modification in accordance with DFW Concessions Tenant Manual.
FLOORS (PUBLIC UNWALLED AREAS)	Terrazzo	Modification in accordance with DFW Concessions Tenant Manual.
GUARDRAIL (F&B LOCATIONS DISPENSING SPIRITS ARE REQUIRED)		Refer to Lease Exhibits
ELECTRICAL	277 / 480 V power provided at dedicated ramp level electrical rooms. Empty conduit with pull cord terminated at lease line from common distribution panel. Switches in switchboard for connection of tenant services.	Panels, branch circuits, transformers, lighting, appliances, convenience outlets, equipment connections within tenant space.

EXHAUST DUCTS FOR KITCHEN HOODS, DISHWASHER, SMOKING (IF APPLICABLE)		Ductwork and rated enclosure from tenant equipment to roof mechanical wells. Roof mounted exhaust air fans.
HVAC	Main supply air duct taps to deliver 1.8 cfm per sq. ft.	VAV Box, grilles, registers, distribution ductwork and controls.

Provisions Summary- Terminal A (continued)

	Base Building	Tenant Improvements
FAN COIL UNIT		Fan Coil Unit and connections (if required) – grilles, registers, distribution ductwork, controls and condensate removal.
CHILLED AND HEATING WATER	Water distribution mains at ceiling with shut off valves and capped taps.	Chilled and heating water connections, control valves and piping to fan coil unit.
DOMESTIC WATER	Capped potable water connection provided below the concourse floor at the lease line with a valve at the main piping.	Connection to 2" main tap, backflow preventer, all distribution piping, fixtures, electrical storage type water heater as needed, drain piping from storage type water heater and connection to fixtures and appliances. Core drill to lease space trap primers to floor sinks and floor drains. Domestic water shall not be used for water cooled refrigeration units
SANITARY WASTE WATER	Below concourse floor, sanitary waste main with capped tap run to the lease line.	Connection to tap, core drill to lease space, upstream cleanouts, traps and fixtures.
GREASE WASTE WATER	Below concourse floor grease waste main piping with capped tap run to cooking concessions lease line.	Grease piping from appliances or interceptors within or below tenant space to the grease piping collection system, including heat trace, heat trace power, insulation and labels. If concession has a disposer, furnish a solids interceptor ahead of grease trap.
PLUMBING VENTS	Main vent up through roof, run to ceiling space of the concession lease line	Connections to main vent and install all vents in accordance with applicable codes.
YELLOW GREASE		Concessionaire to fill barrels, cart full barrels to storage room and collect clean barrels
NATURAL GAS	Medium pressure main natural gas piping across the roof with pressure regulators. Cooking concession low pressure gas tap connections run to lease line, penetrating through roof/wall into the ceiling space of concession lease line capped.	Connections to low pressure taps, connection to cooking appliances and provide manual shut off valves as required.
FIRE ALARM AND DETECTION / VOICE COMMUNICATION SYSTEM	One 75-candela strobe for every 1600 sq. ft. of unobstructed space. In the event of a fire condition within the tenant spaces, or associated evacuation zones which is related to the tenant spaces, the strobe lights will flash and the appropriate pre-recorded and/or live voice messages will be distributed throughout the terminal. Activation of the tenant's system will generate a supervisory signal at the main fire alarm control panel. Speakers must be connected to the terminal's IED Paging System. Strobes must be connected to the Terminal's Fire Alarm System. PA/VE speaker systems are provided in revenue seating areas.	In accordance with the DFW Concessions Tenant Manual.

Provisions Summary- Terminal A (continued)

	Base Building	Tenant Improvements
FIRE PROTECTION SYSTEM	Upright and/or Pendent sprinklers on 1" sprigs or 1" drops.	Modifications to wet pipe sprinkler system to accommodate tenant design, including additional heads or increased pipe sizes must be in accordance with applicable codes and the DFW Concessions Tenant Manual. Tenant to provide special fire protection systems for hoods or other special requirements of the tenant including hand held extinguishers.
FIRE PROOFING	Base building fireproofing.	To meet fire ratings required by code.
ITS/COMMUNICATIONS	Empty conduit(s) with pull cord to pull box at demising wall or below floor from common IT/Communications closed distribution panel.	Media/Wiring to tenant panel to distribution panel. Tenant panel, all devices, equipment and distribution from tenant panel.

7.2 DFW Airport Provided Responsibility Matrix- Terminal A

Following are spread sheets that generally outline provisions by lease space number and tenant type. The specifics of these provisions will be outlined in the tenant lease agreement. All division of building utilities must be coordinated with adjacent tenants. **(Reference Section 2.0, "Design Conditions")**

7.2.1 Building Construction Provisions																	
SPACE NO.	TENANT MIX	Design Condition	ITS Communication	Electrical Conduit	HVAC Air Tap	Natural Gas	Chilled Water	Hot Water	Domestic Water Line	Sanitary Waste Water Line	Cooking Exhaust Right-of-way	Dishwashing Exhaust Right-of-way	Grease Waste Water	Plumbing vents Right-of-way	Base Building Fire Protection	Base Building Fire Alarm	General Notes
Concession Storage																	
A-2-02.8C-A01	Concession Storage	N/A	X	X	X		X	X	X	X					X	X	
A-2-055B-L01	Concession Storage	N/A	X	X	X		X	X	X	X					X	X	
A-2-080B-L01	Concession Storage	N/A	X	X	X		X	X	X	X					X	X	
A-2-082B-A01	Concessions Storage	N/A	X	X	X		X	X							X	X	
A-2-086B-A01	Concession Storage	N/A	X	X	X		X	X	X	X					X	X	
A-2-097F-A02	Concession Storage	A6	X	X	X			X	X	X					X	X	
A-2-104F-A01	Concession Storage	N/A	X	X	X		X								X	X	
A-2-133C-A01	Concession Storage	N/A	X	X	X		X	X	X	X					X	X	

General Notes:

1. Terrazzo provided floor in open seating areas.
2. Airport ceiling system at open seating will include HVAC, Fire Protection, and lighting.

DFW Airport Provided Responsibility Matrix- Terminal A (continued)

Building Construction Provisions																	
SPACE NO.	TENANT MIX	Design Condition	ITS Communication	Electrical Conduit	HVAC Air Tap	Natural Gas	Chilled Water	Hot Water	Domestic Water Line	Sanitary Waste Water Line	Cooking Exhaust Right-of-way	Dishwashing Exhaust Right-of-way	Grease Waste Water	Plumbing vents Right-of-way	Base Building Fire Protection	Base Building Fire Alarm	General Notes
Food & Beverage																	
A-1-082C-A01	Table Service	N/A	X	X	X	X	X	X	X	X	X	X	X	X	X	X	
A-2-012D-A02	Cafe/Bar	A1	X	X	X	X	X	X	X	X	X	X	X	X	X	X	
A-2-013C-A01	Walk-away	A6	X	X	X		X	X	X	X	X		X		X	X	
A-2-026D-A01	Walk-away	A1	X	X	X	X	X	X	X	X	X	X	X	X	X	X	
A-2-031C-A01	Table Service	A2	X	X	X	X	X	X	X	X	X	X	X	X	X	X	
A-2-031E-A01	Table Service	B2	X	X	X	X	X	X	X	X	X	X	X	X	X	X	1, 2
A-2-034C-A01	Walk-away	A1	X	X	X	X	X	X	X	X	X	X	X	X	X	X	
A-2-041C-A01	Quick Service	A1 sim.	X	X	X	X	X	X	X	X	X	X	X	X	X	X	
A-2-041D-A01	Quick Service	B3	X	X	X	X	X	X	X	X	X	X	X	X	X	X	1, 2
A-2-041E-A01	Quick Service	B3	X	X	X	X	X	X	X	X	X	X	X	X	X	X	1, 2
A-2-043C-A01	Quick Service	A2	X	X	X	X	X	X	X	X	X	X	X	X	X	X	
A-2-048C-A01	Cafe/Bar	A3	X	X	X	X	X	X	X	X	X	X	X	X	X	X	
A-2-053C-A02	Walk-away	A3	X	X	X	X	X	X	X	X	X	X	X	X	X	X	
A-2-062D-A01	Walk-away	A5	X	X	X	X	X	X	X	X	X	X	X	X	X	X	
A-2-063D-A01	Walk-away	A5	X	X	X	X	X	X	X	X	X	X	X	X	X	X	
A-2-068D-A01	Table Service	A2	X	X	X	X	X	X	X	X	X	X	X	X	X	X	
A-2-085C-A01	Café/Bar	A1	X	X	X	X	X	X	X	X	X	X	X	X	X	X	
A-2-085D-A01	Fast Casual	A1	X	X	X	X	X	X	X	X	X	X	X	X	X	X	
A-2-090D-A01	Walk-away	A1	X	X	X	X	X	X	X	X	X	X	X	X	X	X	
A-2-094C-A01	Table Service	A2	X	X	X	X	X	X	X	X	X	X	X	X	X	X	
A-2-099D-A01	Table Service	B2	X	X	X	X	X	X	X	X	X	X	X	X	X	X	1, 2
A-2-105D-A01	Table Service	B4	X	X	X	X	X	X	X	X	X	X	X	X	X	X	1, 2
A-2-110D-A01	Quick Service	B2	X	X	X	X	X	X	X	X	X	X	X	X	X	X	1, 2
A-2-114D-A01	Quick Service	A4	X	X	X	X	X	X	X	X	X	X	X	X	X	X	1, 2
A-2-122D-A01	Walk-away	A1/A5	X	X	X	X	X	X	X	X	X	X	X	X	X	X	

General Notes:

1. Terrazzo provided floor in open seating areas.
2. Airport ceiling system at open seating will include HVAC, Fire Protection, and lighting.

DFW Airport Provided Responsibility Matrix- Terminal A (continued)

Building Construction Provisions																	
SPACE NO.	TENANT MIX	Design Condition	ITS Communication	Electrical Conduit	Natural Gas	HVAC Air Tap	Chilled Water	Hot Water	Domestic Water Line	Sanitary Waste Water Line	Cooking Exhaust Right-of-way	Dishwashing Exhaust Right-of-way	Grease Waste Water	Plumbing vents Right-of-way	Base Building Fire Protection	Base Building Fire Alarm	General Notes
News																	
A-2-012D-A01	News & Books	A3	X	X		X	X	X	X						X	X	
A-2-029D-A01	News & Books	B1	X	X		X	X	X	X	X		X	X	X	X	X	
A-2-035B-L01	News & Books	C2	X	X		X	X	X	X	X		X	X	X	X	X	
A-2-059C-A01	News & Books	A1	X	X		X		X	X	X					X	X	
A-2-083D-A01	Convenience Retail	A1/A5	X	X		X	X	X	X	X		X	X	X	X	X	
A-2-107A-L01	News & Books	C2 sim.	X	X		X	X	X	X	X		X	X	X	X	X	
A-2-113D-A01	News & Books	B1	X	X		X	X	X	X	X					X	X	
A-2-CC1-A01	News	N/A	X	X		X	X	X	X		X	X	X	X	X	X	

General Notes:

1. Terrazzo provided floor in open seating areas.
2. Airport ceiling system at open seating will include HVAC, Fire Protection, and lighting.

DFW Airport Provided Responsibility Matrix- Terminal A (continued)

Building Construction Provisions																	
SPACE NO.	TENANT MIX	Design Condition	ITS Communication	Electrical Conduit	HVAC Air Tap	Natural Gas	Chilled Water	Hot Water	Domestic Water Line	Sanitary Waste Water Line	Cooking Exhaust Right-of-way	Dishwashing Exhaust Right-of-way	Grease Waste Water	Plumbing vents Right-of-way	Base Building Fire Protection	Base Building Fire Alarm	General Notes
Service																	
A-2-036C-A01	Shoe Shine	A3	X	X	X				X	X				X	X	X	
A-2-082C-A01	Salon/Spa	A1	X	X	X				X	X				X	X	X	
A-2-097F-A03	Shoe Shine	A6	X	X	X				X	X				X	X	X	
A-2-131C-A01	Business Center	A1	X	X	X				X	X					X	X	
A-2-132C-A01	Nap Center	A1	X	X	X				X	X				X	X	X	

General Notes:

1. Terrazzo provided floor in open seating areas.
2. Airport ceiling system at open seating will include HVAC, Fire Protection, and lighting.

DFW Airport Provided Responsibility Matrix- Terminal A (continued)

Building Construction Provisions																
SPACE NO.	TENANT MIX	Design Condition	ITS Communication	Electrical Conduit	HVAC Air Tap	Natural Gas	Chilled Water	Domestic Water Line	Sanitary Waste Water Line	Cooking Exhaust Right-of-way	Dishwashing Exhaust Right-of-way	Grease Waste Water	Plumbing vents Right-of-way	Base Building Fire Protection	Base Building Fire Alarm	General Notes
Specialty Retail																
A-2-027D-A01	Entertainment & Consumer Electronics	A1	X	X	X			X	X					X	X	
A-2-037D-A01	Gifts / Specialty	A4	X	X	X		X	X	X					X	X	1, 2
A-2-038C-A01	Gifts/Specialty	A1	X	X	X			X	X					X	X	
A-2-040C-A01	Packaged Foods	A1	X	X	X			X	X					X	X	
A-2-045E-A01	Packaged Foods	B1	X	X	X		X	X	X	X		X	X	X	X	
A-2-046C-A01	Apparel & Accessories	A1	X	X	X			X	X					X	X	
A-2-053D-A01	Travel	A1	X	X	X			X	X					X	X	
A-2-054C-A01	Personal Care	A3	X	X	X			X	X					X	X	
A-2-064C-A01	Entertainment & Electronics	A1	X	X	X			X	X					X	X	
A-2-078C-A01	Apparel & Accessories	A3	X	X	X			X	X					X	X	
A-2-080C-A01	Apparel & Accessories	C1	X	X	X		X	X	X					X	X	
A-2-086C-A01	Gifts/Specialty	A1	X	X	X		X	X	X			X	X	X	X	
A-2-090C-A01	Apparel & Accessories	C1	X	X	X			X	X					X	X	
A-2-095D-A01	Packaged Foods	A5	X	X	X			X	X					X	X	1, 2
A-2-096D-A01	Gifts/Specialty	A4	X	X	X			X	X					X	X	1, 2
A-2-097E-A01	Apparel & Accessories	B1	X	X	X		X	X	X					X	X	
A-2-097F-A01	Personal Care	B1	X	X	X			X	X					X	X	
A-2-104C-A01	Personal Care	A1	X	X	X			X	X					X	X	
A-2-106C-A01	Apparel & Accessories	A1	X	X	X			X	X					X	X	
A-2-110C-A01	Apparel & Accessories	A1 sim.	X	X	X			X	X					X	X	
A-2-124C-A01	Entertainment & Consumer Electronics	A1	X	X	X			X	X					X	X	

General Notes:

1. Terrazzo provided floor in open seating areas.
2. Airport ceiling system at open seating will include HVAC, Fire Protection, and lighting.

7.3 Concessions Service Matrix- Terminal A

Concessions Service Matrix															
CONCESSION UNIT	CONCESSION TYPE	ARCHITECTURE			IT	ELECTRICAL				MECHANICAL		PLUMBING			
		Area (S.F.)	Design Condition	Type of Construction	ITS / Communication	Estimated Watts/SF	Estimated Service Size @ 480V, 3 Ph	Estimated Conduit Size	Installed Conduit Size	HVAC VAV Supply Air Volume	Supply Air Temp	Domestic Cold Water	Sanitary Sewer	Grease Waste	Natural Gas**
Terminal A Concourse Level															
A-2-02.8C-A01	Concession Storage	1928	N/A	1B		75	300	3"	4"	1.8 cfm	55	2"	4"		
A-2-012D-A01	News	176	A3	1B	Yes	50	100	1.5"	2"	1.8 cfm	55	2"	4"	4" Yes	
A-2-012D-A02	Food & Beverage	733	A1	1B		50	100	1.5"	2"	1.8 cfm	55	2"	4"		
A-2-013C-A01	Food & Beverage	133	A6	1B	Yes	10	100	1.5"	2"	1.8 cfm	55	2"	4"		
A-2-026D-A01	Food & Beverage	627	A1	1B	Yes	50	100	1.5"	2"	1.8 cfm	55	2"	4"	4" Yes	
A-2-027D-A01	Specialty Retail	729	A1	1B	Yes	10	100	1.5"	2"	1.8 cfm	55	2"	4"	4"	
A-2-029D-A01	News	2150	B1	1B	Yes	50	225	2.5"	3"	1.8 cfm	55	2"	4"		
A-2-031C-A01	Food & Beverage	5916	A2	1B	Yes	100	100	3(3")	3(4")	1.8 cfm	55	2"	4"	4" Yes	
A-2-031E-A01	Food & Beverage	4206	B2	1B	Yes	100	500	2(2.5")	2(4")	1.8 cfm	55	2"	4"	4" Yes	
A-2-034C-A01	Food & Beverage	969	A1	1B	Yes	50	225	2.5"	3"	1.8 cfm	55	2"	4"	4" Yes	
A-2-035B-L01	News	347	C2	1B	Yes	10	100	1.5"	2"	1.8 cfm	55	2"	4"		
A-2-036C-A01	Service	220	A3	1B	Yes	10	100	1.5"	2"	1.8 cfm	55	2"	4"		
A-2-037D-A01	Specialty Retail	1888	A4	1B	Yes	10	100	1.5"	2"	1.8 cfm	55	2"	4"		
A-2-038C-A01	Specialty Retail	971	A1	1B	Yes	10	100	1.5"	2"	1.8 cfm	55	2"	4"		
A-2-040C-A01	Specialty Retail	509	A1	1B	Yes	10	100	1.5"	2"	1.8 cfm	55	2"	4"		
A-2-041C-A01	Food & Beverage	1161	A1 sim.	1B	Yes	50	100	1.5"	2"	1.8 cfm	55	2"	4"	4" Yes	
A-2-041D-A01	Food & Beverage	2308	B3	1B	Yes	50	225	2.5"	3"	1.8 cfm	55	2"	4"	4" Yes	

Concessions Service Matrix- Terminal A (continued)

Concessions Service Matrix															
CONCESSION UNIT	CONCESSION TYPE	ARCHITECTURE			IT	ELECTRICAL				MECHANICAL		PLUMBING			
		Area (S.F.)	Design Condition	Type of Construction	ITS / Communication	Estimated Watts/SF	Estimated Service Size @ 480V, 3 Ph	Estimated Conduit Size	Installed Conduit Size	HVAC VAV Supply Air Volume	Supply Air Temp	Domestic Cold Water	Sanitary Sewer	Grease Waste	Natural Gas**
Terminal A Concourse Level															
A-2-041E-A01	Food & Beverage	2638	B3	1B	Yes	50	225	2.5"	3"	1.8 cfm	55	2"	4"	4"	Yes
A-2-043C-A01	Food & Beverage	2047	A2	1B	Yes	50	225	2.5"	3"	1.8 cfm	55	2"	4"	4"	Yes
A-2-045E-A01	Specialty Retail	570	B1	1B	Yes	10	100	1.5"	2"	1.8 cfm	55	2"	4"		
A-2-046C-A01	Specialty Retail	908	A1	1B	Yes	10	100	1.5"	2"	1.8 cfm	55	2"	4"		
A-2-048C-A01	Food & Beverage	833	A3	1B	Yes	20	100	1.5"	2"	1.8 cfm	55	2"	4"	4"	Yes
A-2-053C-A02	Food & Beverage	277	A1	1B	Yes	20	100	1.5"	2"	1.8 cfm	55	2"	4"	4"	Yes
A-2-053D-A01	Specialty Retail	1042	A1	1B	Yes	10	100	1.5"	2"	1.8 cfm	55	2"	4"		
A-2-054C-A01	Specialty Retail	781	A3	1B	Yes	10	100	1.5"	2"	1.8 cfm	55	2"	4"		
A-2-055B-L01	Concessions Storage	76	N/A	1B	No	10	100	1.5"	2"	1.8 cfm	55	2"	4"		
A-2-059C-A01	News	902	A1	1B	Yes	10	100	1.5"	2"	1.8 cfm	55	2"	4"		
A-2-062D-A01	Food & Beverage	1021	A5	1B	Yes	50	100	1.5"	2"	1.8 cfm	55	2"	4"	4"	Yes
A-2-063D-A01	Food & Beverage	520	A1	1B	Yes	50	100	1.5"	2"	1.8 cfm	55	2"	4"	4"	Yes
A-2-064C-A01	Specialty Retail	1132	A1	1B	Yes	10	100	1.5"	2"	1.8 cfm	55	2"	4"		
A-2-068D-A01	Food & Beverage	2831	A2	1B	Yes	75	400	3.5"	4"	1.8 cfm	55	2"	4"	4"	Yes
A-2-078C-A01	Specialty Retail	595	A3	1B	Yes	10	100	1.5"	2"	1.8 cfm	55	2"	4"		
A-2-080B-L01	Concessions Storage	273	N/A	1B	Yes	10	100	1.5"	2"	1.8 cfm	55	2"	4"		
A-2-080C-A01	Specialty Retail	616	C1	1B	Yes	10	100	1.5"	2"	1.8 cfm	55	2"	4"		Yes
A-2-082B-A01	Concessions Storage	205	N/A	1B	No	?	?	?	?	1.8 cfm	55	2"	4"		

Concessions Service Matrix- Terminal A (continued)

Concessions Service Matrix															
CONCESSION UNIT	CONCESSION TYPE	ARCHITECTURE			IT	ELECTRICAL				MECHANICAL		PLUMBING			
		Area (S.F.)	Design Condition	Type of Construction	ITS / Communication	Estimated Watts/SF	Estimated Service Size @ 480V, 3 Ph	Estimated Conduit Size	Installed Conduit Size	HVAC VAV Supply Air Volume	Supply Air Temp	Domestic Cold Water	Sanitary Sewer	Grease Waste	Natural Gas**
Terminal A Concourse Level															
A-2-082C-A01	Service	2170	A1	1B	Yes	50	100	1.5"	2"	1.8 cfm	55	2"	4"		
A-2-083D-A01	News	1308	A1/A5	1B	Yes	10	100	1.5"	2"	1.8 cfm	55	2"	4"		
A-2-085C-A01	Food & Beverage	1943	A1	1B	Yes	50	150	2"	3"	1.8 cfm	55	2"	4"	4"	Yes
A-2-085D-A01	Food & Beverage	2004	A2	1B	Yes	50	150	2"	3"	1.8 cfm	55	2"	4"	4"	Yes
A-2-086B-A01	Concessions Storage	845	N/A	1B	Yes	10	100	1.5"	2"	1.8 cfm	55	2"	4"		
A-2-086C-A01	Specialty Retail	1414	A1	1B	Yes	50	225	2.5"	3"	1.8 cfm	55	2"	4"		
A-2-090C-A01	Specialty Retail	705	C1	1B	Yes	50	225	2.5"	3"	1.8 cfm	55	2"	4"		
A-2-090D-A01	Food & Beverage	569	A1	1B	Yes	50	100	1.5"	2"	1.8 cfm	55	2"	4"	4"	Yes
A-2-094C-A01	Food & Beverage	5254	A2	1B	Yes	50	100	1.5"	3 (4")	1.8 cfm	55	2"	4"	4"	Yes
A-2-095D-A01	Specialty Retail	533	A5	1B	Yes	20	100	1.5"	2"	1.8 cfm	55	2"	4"		
A-2-096D-A01	Specialty Retail	971	A4	1B	No	20	100	1.5"	2"	1.8 cfm	55	2"	4"		
A-2-097E-A01	Specialty Retail	989	B1	1B	Yes	50	225	2.5"	3"	1.8 cfm	55	2"	4"		
A-2-097F-A01	Specialty Retail	593	B1	1B	Yes	10	100	1.5"	2"	1.8 cfm	55	2"	4"		
A-2-097F-A02	Concession Storage	459	A6	1B	Yes	10	100	1.5"	2"	1.8 cfm	55	2"	4"		
A-2-097F-A03	Service	272	A6	1B	Yes	?	?	?	?	1.8 cfm	55	2"	4"	?	?
A-2-099D-A01	Food & Beverage	3228	B2	1B	Yes	100	500	2(2.5")	2(4")	1.8 cfm	55	2"	4"	4"	Yes
A-2-104C-A01	Specialty Retail	804	A1	1B	Yes	10	100	1.5"	2"	1.8 cfm	55	2"	4"		
A-2-104F-A01	Concessions Storage	330	N/A	1B	Yes	10	100	1.5"	2"	1.8 cfm	55	2"	4"		
A-2-105D-A01	Food & Beverage	3238	B4	1B	Yes	100	500	2(2.5")	2(4")	1.8 cfm	55	2"	4"	4"	Yes

Concessions Service Matrix- Terminal A (continued)

Concessions Service Matrix															
CONCESSION UNIT	CONCESSION TYPE	ARCHITECTURE			IT	ELECTRICAL				MECHANICAL		PLUMBING			
		Area (S.F.)	Design Condition	Type of Construction	ITS / Communication	Estimated Watts/SF	Estimated Service Size @ 480V, 3 Ph	Estimated Conduit Size	Installed Conduit Size	HVAC VAV Supply Air Volume	Supply Air Temp	Domestic Cold Water	Sanitary Sewer	Grease Waste	Natural Gas**
Terminal A Concourse Level															
A-2-106C-A01	Specialty Retail	1009	A1	1B	Yes	10	100	1.5"	2"	1.8 cfm	55	2"	4"		
A-2-107A-L01	News	269	C2 sim.	1B	Yes	10	100	1.5"	2"	1.8 cfm	55	2"	4"		
A-2-110C-A01	Specialty Retail	1642	A1 sim.	1B	Yes	10	100	1.5"	2"	1.8 cfm	55	2"	4"		
A-2-110D-A01	Food & Beverage	3410	B2	1B	Yes	100	500	2(2.5")	2(4")	1.8 cfm	55	2"	4"	4"	Yes
A-2-113D-A01	News	2784	B1	1B	Yes	50	250	2.5"	3"	1.8 cfm	55	2"	4"		
A-2-114D-A01	Food & Beverage	1715	A4	1B	Yes	50	150	2"	3"	1.8 cfm	55	2"	4"	4"	Yes
A-2-122D-A01	Food & Beverage	634	A1/A5	1B	Yes	50	150	2"	3"	1.8 cfm	55	2"	4"		
A-2-124C-A01	Specialty Retail	775	A1	1B	Yes	10		2"		1.8 cfm	55	2"	4"		
A-2-129C-A01	News	250	A1	1B	Yes	10	100	1.5"	2"	1.8 cfm	55	2"	4"		
A-2-131C-A01	Service	920	A1	1B	Yes	20	100	1.5"	2"	1.8 cfm	55	2"	4"		
A-2-132C-A01	Service	920	A1	1B	Yes	20	150	1.5"	2"	1.8 cfm	55	2"	4"		
A-2-133C-A01	Concession Storage	1712	N/A	1B	Yes	20	100	1.5"	2"	1.8 cfm	55	2"	4"		
A-2-CC1-A01	News	147	N/A	1B	Yes	10	100	1.5"	2"	1.8 cfm	55				
A-1-082C-A01	Food & Beverage	6808	N/A	1B	Yes	100		3(2")		1.8 cfm	55	2"	4"	4"	Yes

* Only Lighting and convenience receptacles provided

** Regulator Performance to be determined according to Concession requirements.

THIS PAGE LEFT INTENTIONALLY BLANK

PLACE HOLDER
11" X 17" PLAN

PLACE HOLDER 11" X 17" PLAN

8.0 EXHIBITS TERMINAL B

8.1 Provisions Summary- Terminal B

NOTE: Conditions listed below may not apply to all lease spaces. Refer to DFW Airport Provided Responsibility Matrix in section 8.2.

	Base Building	Tenant Improvements
STOREFRONT	Curtain wall side panels flanking neutral frame. Multi-bay tenants may elect to remove this DFW provided storefront from center column location. A formal request for deletion must be forwarded to DFW Concessions Department in writing prior to initial design submittal.	Build-out by tenant inside of neutral frame opening in accordance with the DFW Concessions Tenant Manual.
NEUTRAL FRAME	Consistent metal frame surround defining each storefront opening.	3/4" black reveal separating neutral frame from any tenant designed store elements.
DEMISING WALLS (TYPE 1) (All demising walls shown on Lease Exhibits are type 1 U.O.N.)	Refer to Lease Exhibits	Gypsum wallboard, insulation and finishes.
DEMISING WALL (TYPE 2)	Refer to Lease Exhibits	Gypsum wallboard, insulation and finishes. 60% of Type 2 demising walls can be translucent or open but cannot be open for pass-through circulation.
CEILINGS	Exposed structure.	By tenant to approved design criteria.
ACCOUSTICAL SOUND TRANSMISSION PROTECTION		In accordance with the DFW Concessions Tenant Manual.
FLOORS (TENANT INTERIOR)	Existing exposed concrete	Floor finishes in accordance with DFW Concessions Tenant Manual.
FLOORS (PUBLIC SEATING)	Terrazzo	Modification in accordance with DFW Concessions Tenant Manual.
FLOORS (PUBLIC UNWALLED AREAS)	Terrazzo	Modification in accordance with DFW Concessions Tenant Manual.
GUARDRAIL (F&B LOCATIONS DISPENSING SPIRITS ARE REQUIRED)		Refer to Lease Exhibits
ELECTRICAL	277 / 480 V power provided at dedicated ramp level electrical rooms. Empty conduit with pull cord terminated at lease line from common distribution panel. Switches in switchboard for connection of tenant services.	Panels, branch circuits, transformers, lighting, appliances, convenience outlets, equipment connections within tenant space.
EXHAUST DUCTS FOR KITCHEN HOODS, DISHWASHER, SMOKING (IF APPLICABLE)		Ductwork and rated enclosure from tenant equipment to roof mechanical wells. Roof mounted exhaust air fans.
HVAC	Main supply air duct taps to deliver 1.8 cfm per sq. ft.	VAV Box, grilles, registers, distribution ductwork and controls.

Provisions Summary- Terminal B (continued)

	Base Building	Tenant Improvements
FAN COIL UNIT		Fan Coil Unit and connections (if required) – grilles, registers, distribution ductwork, controls and condensate removal.
CHILLED AND HEATING WATER	Water distribution mains at ceiling with shut off valves and capped taps.	Chilled and heating water connections, control valves and piping to fan coil unit.
DOMESTIC WATER	Capped potable water connection provided below the concourse floor at the lease line with a valve at the main piping.	Connection to 2" main tap, backflow preventer, all distribution piping, fixtures, electrical storage type water heater as needed, drain piping from storage type water heater and connection to fixtures and appliances. Core drill to lease space trap primers to floor sinks and floor drains. Domestic water shall not be used for water cooled refrigeration units
SANITARY WASTE WATER	Below concourse floor, sanitary waste main with capped tap run to the lease line.	Connection to tap, core drill to lease space, upstream cleanouts, traps and fixtures.
GREASE WASTE WATER	Below concourse floor grease waste main piping with capped tap run to cooking concessions lease line.	Grease piping from appliances or interceptors within or below tenant space to the grease piping collection system, including heat trace, heat trace power, insulation and labels. If concession has a disposer, furnish a solids interceptor ahead of grease trap.
PLUMBING VENTS	Main vent up through roof, run to ceiling space of the concession lease line	Connections to main vent and install all vents in accordance with applicable codes.
YELLOW GREASE		Concessionaire to fill barrels, cart full barrels to storage room and collect clean barrels
NATURAL GAS	Medium pressure main natural gas piping across the roof with pressure regulators. Cooking concession low pressure gas tap connections run to lease line, penetrating through roof/wall into the ceiling space of concession lease line capped.	Connections to low pressure taps, connection to cooking appliances and provide manual shut off valves as required.
FIRE ALARM AND DETECTION / VOICE COMMUNICAITON SYSTEM	One 75-candela strobe for every 1600 sq. ft. of unobstructed space. In the event of a fire condition within the tenant spaces, or associated evacuation zones which is related to the tenant spaces, the strobe lights will flash and the appropriate pre-recorded and/or live voice messages will be distributed throughout the terminal. Activation of the tenant's system will generate a supervisory signal at the main fire alarm control panel. Speakers must be connected to the terminal's IED Paging System. Strobes must be connected to the Terminal's Fire Alarm System. PA/VE speaker systems are provided in revenue seating areas.	In accordance with the DFW Concessions Tenant Manual.

Provisions Summary- Terminal B (continued)

	Base Building	Tenant Improvements
FIRE PROTECTION SYSTEM	Upright and/or Pendent sprinklers on 1" sprigs or 1" drops.	Modifications to wet pipe sprinkler system to accommodate tenant design, including additional heads or increased pipe sizes must be in accordance with applicable codes and the DFW Concessions Tenant Manual. Tenant to provide special fire protection systems for hoods or other special requirements of the tenant including hand held extinguishers.
FIRE PROOFING	Base building fireproofing.	To meet fire ratings required by code.
ITS/COMMUNICATIONS	Empty conduit(s) with pull cord to pull box at demising wall or below floor from common IT/Communications closed distribution panel.	Media/Wiring to tenant panel to distribution panel. Tenant panel, all devices, equipment and distribution from tenant panel.

8.2 DFW Airport Provided Responsibility Matrix- Terminal B

Following are spread sheets that generally outline provisions by lease space number and tenant type. The specifics of these provisions will be outlined in the tenant lease agreement. All division of building utilities must be coordinated with adjacent tenants. **(Reference Section 2.0, "Design Conditions")**

8.2.1 Building Construction Provisions																
SPACE NO.	TENANT MIX	Design Condition	ITS Communication	Electrical Conduit	HVAC Air Tap	Natural Gas	Chilled Water	Domestic Water Line	Sanitary Waste Water Line	Cooking Exhaust Right-of-way	Dishwashing Exhaust Right-of-way	Grease Waste Water	Plumbing vents Right-of-way	Base Building Fire Protection	Base Building Fire Alarm	General Notes
Deferred Concession																
B-2-029F-A01	Deferred	B1	Yes	X	X	X	X	X						X	X	
B-2-050C-A01	Deferred	A1	Yes	X	X	X	X	X						X	X	
B-2-115D-A01	Deferred	A2	Yes	X	X	X	X	X						X	X	

General Notes:

1. Terrazzo provided floor in open seating areas.
2. Airport ceiling system at open seating will include HVAC, Fire Protection, and lighting.

DFW Airport Provided Responsibility Matrix- Terminal B (continued)

Building Construction Provisions																
SPACE NO.	TENANT MIX	Design Condition	ITS Communication	Electrical Conduit	HVAC Air Tap	Natural Gas	Chilled Water	Domestic Water Line	Sanitary Waste Water Line	Cooking Exhaust Right-of-way	Dishwashing Exhaust Right-of-way	Grease Waste Water	Plumbing vents Right-of-way	Base Building Fire Protection	Base Building Fire Alarm	General Notes
Concession Storage																
B-2-102Y-L01	Concessions Office	?	X	X	X	X	X	X	X	X	X	X	X	X	X	
B-2-128C-A01	Concessions Office	?	X	X	X	X	X	X	X	X	X	X	X	X	X	
B-2-128C-A02	Concessions Office	?	X	X	X	X	X	X	X	X	X	X	X	X	X	
B-2-129C-A01	Concessions Office	?	X	X	X	X	X	X	X	X	X	X	X	X	X	
B-2-129C-A02	Concessions Office	?	X	X	X	X	X	X	X	X	X	X	X	X	X	
B-2-129C-A03	Concessions Office	?	X	X	X	X	X	X	X	X	X	X	X	X	X	
B-2-130C-A02	Concessions Office	?	X	X	X	X	X	X	X	X	X	X	X	X	X	
B-2-130C-A01	Concessions Office	?	X	X	X	X	X	X	X	X	X	X	X	X	X	

General Notes:

1. Terrazzo provided floor in open seating areas.
2. Airport ceiling system at open seating will include HVAC, Fire Protection, and lighting.

DFW Airport Provided Responsibility Matrix- Terminal B (continued)

Building Construction Provisions																
SPACE NO.	TENANT MIX	Design Condition	ITS Communication	Electrical Conduit	HVAC Air Tap	Natural Gas	Chilled Water	Domestic Water Line	Sanitary Waste Water Line	Cooking Exhaust Right-of-way	Dishwashing Exhaust Right-of-way	Grease Waste Water	Plumbing vents Right-of-way	Base Building Fire Protection	Base Building Fire Alarm	General Notes
Food & Beverage																
B-2-014D-A01	Quick Service	A1	X	X	X	X	X	X	X	X	X	X	X	X	X	
B-2-018C-A01	Walk-away	A3	X	X	X	X	X	X	X	X		X	X	X	X	
B-2-033C-A01	Walk-away	A3	X	X	X	X	X	X	X	X		X	X	X	X	
B-2-033E-A01	Table Service	N/A	X	X	X	X	X	X	X	X	X	X	X	X	X	1, 2
B-2-041D-A01	Quick Service	B3	X	X	X	X	X	X	X	X	X	X	X	X	X	
B-2-042D-A01	Quick Service	B3	X	X	X	X	X	X	X	X	X	X	X	X	X	1, 2
B-2-054D-A01	Quick Service	A1/A5	X	X	X	X	X	X	X	X	X	X	X	X	X	
B-2-077C-A01	Walk-away	A1	X	X	X	X	X	X	X	X		X	X	X	X	
B-2-077D-A01	Cafe/Bar	A2	X	X	X	X	X	X	X	X	X	X	X	X	X	
B-2-078C-A01	Walk-away	A1	X	X	X	X	X	X	X	X		X	X	X	X	
B-2-086C-A01	Deferred	A1	X	X	X	X	X	X	X	X		X	X	X	X	
B-2-092C-A01	Walk-away	A1	X	X	X	X	X	X	X	X		X	X	X	X	
B-2-093E-A01	Walk-away	B1	X	X	X	X	X	X	X	X	X	X	X	X	X	
B-2-095D-A01	Café / Bar	B2	X	X	X	X	X	X	X	X	X	X	X	X	X	1, 2
B-2-098D-A01	Walk-away with Seating	B5	X	X	X	X	X	X	X	X	X	X	X	X	X	
B-2-098D-A01	Seating (Above)															
B-2-104C-A01	Quick Service	A1	X	X	X	X	X	X	X	X	X	X	X	X	X	
B-2-106D-A01	Quick Service	B2	X	X	X	X	X	X	X	X	X	X	X	X	X	1, 2
B-2-109C-A01	Walk-away	A3	X	X	X	X	X	X	X	X		X	X	X	X	
B-2-115D-A01	TBD	A1/A5	X	X	X	X	X	X	X	X	X	X	X	X	X	
B-2-111C-A01	Walk-away	A1	X	X	X	X	X	X	X	X	X	X	X	X	X	

DFW Airport Provided Responsibility Matrix- Terminal B (continued)

Building Construction Provisions																
SPACE NO.	TENANT MIX	Design Condition	ITS Communication	Electrical Conduit	HVAC Air Tap	Natural Gas	Chilled Water	Domestic Water Line	Sanitary Waste Water Line	Cooking Exhaust Right-of-way	Dishwashing Exhaust Right-of-way	Grease Waste Water	Plumbing vents Right-of-way	Base Building Fire Protection	Base Building Fire	General Notes
News																
B-2-015D-A01	News & Book	A1	X	X	X		X	X	X		X	X	X	X	X	
B-2-018B-L01	News & Book	A3	X	X	X		X	X	X		X	X	X	X	X	
B-2-045E-A01	News & Book	B1	X	X	X		X	X	X		X	X	X	X	X	
B-2-070D-A01	Convenience Retail	A1/A5	X	X	X		X	X	X		X	X	X	X	X	
B-2-092B-L01	News & Book	C2	X	X	X		X	X	X		X	X	X	X	X	
B-2-098E-A01	News	B5	X	X	X		X	X	X		X	X	X	X	X	
B-2-116C-A01	News & Book	A1	X	X	X		X	X	X		X	X	X	X	X	
S-2-006N-A01	News & Book	N/A	X	X	X		X	X	X					X	X	
P-2-002J-A01	News	N/A	X	X	X		X	X	X		X	X	X	X	X	
P-2-003R-A01	F & B	N/A	X	X	X	X	X	X	X	X	X	X	X	X	X	

General Notes:

1. Terrazzo provided floor in open seating areas.
2. Airport ceiling system at open seating will include HVAC, Fire Protection, and lighting.

DFW Airport Provided Responsibility Matrix- Terminal B (continued)

Building Construction Provisions																
SPACE NO.	TENANT MIX	Design Condition	ITS Communication	Electrical Conduit	HVAC Air Tap	Natural Gas	Chilled Water	Domestic Water Line	Sanitary Waste Water Line	Cooking Exhaust Right-of-way	Dishwashing Exhaust Right-of-way	Grease Waste Water	Plumbing vents Right-of-way	Base Building Fire Protection	Base Building Fire Alarm	General Notes
Service																
B-2-034C-A01	Shoe Shine	A3	X	X	X			X	X				X	X	X	
B-2-091D-A01	Shoe Shine	A5	X	X	X			X	X				X	X	X	

General Notes:

1. Terrazzo provided floor in open seating areas.
2. Airport ceiling system at open seating will include HVAC, Fire Protection, and lighting.

DFW Airport Provided Responsibility Matrix- Terminal B (continued)

Building Construction Provisions																
SPACE NO.	TENANT MIX	Design Condition	ITS Communication	Electrical Conduit	HVAC Air Tap	Natural Gas	Chilled Water	Domestic Water Line	Sanitary Waste Water Line	Cooking Exhaust Right-of-way	Dishwashing Exhaust Right-of-way	Grease Waste Water	Plumbing vents Right-of-way	Base Building Fire Protection	Base Building Fire Alarm	General Notes
Specialty Retail																
B-2-029E-A01	Specialty Retail	B1	X	X	X			X	X					X	X	
B-2-030C-A01	Entertainment & Consumer Electronics	A1	X	X	X			X	X					X	X	
B-2-067D-A01	Apparel & Accessories	A1 / A5	X	X	X			X	X					X	X	
B-2-090D-A01	Apparel & Accessories	A1	X	X	X			X	X					X	X	
B-2-092D-A01	Apparel & Accessories	A1	X	X	X			X	X					X	X	
B-2-094C-A01	Specialty retail	A1	X	X	X			X	X					X	X	
B-2-104Y-L01	Specialty Retail	?	X	X	X			X	X					X	X	
B-2-105C-A01	Packaged Foods	A1	X	X	X			X	X					X	X	
B-2-109D-A01	Gifts/Specialty	B1	X	X	X		X	X	X					X	X	

General Notes:

1. Terrazzo provided floor in open seating areas.
2. Airport ceiling system at open seating will include HVAC, Fire Protection, and lighting.

8.3 Concessions Service Matrix- Terminal B

Concessions Service Matrix															
CONCESSION UNIT	CONCESSION TYPE	ARCHITECTURE			IT	ELECTRICAL				MECHANICAL		PLUMBING			
		Area (S.F.)	Design Condition	Type of Construction	ITS / Communication	Estimated Watts/SF	Estimated Service Size @ 480V, 3 Ph	Estimated Conduit Size	Installed Conduit Size	HVAC VAV Supply Air Volume	Supply Air Temp	Domestic Cold Water	Sanitary Sewer	Grease Waste	Natural Gas**
Terminal B Concourse Level															
B-2-014D-A01	Food & Beverage	897	A1	1B	Yes	75	100	1.5"	2"	1.8 cfm	55	2"	4"	4"	Yes
B-2-015D-A01	News	890	A1	1B	Yes	10	100	1.5"	2"	1.8 cfm	55	2"	4"		
B-2-018B-L01	News	203	A3	1B	Yes	50	100	1.5"	2"	1.8 cfm	55	2"	4"		
B-2-018C-A01	Food & Beverage	440	A3	1B	Yes	75	100	1.5"	2"	1.8 cfm	55	2"	4"	4"	Yes
B-2-029E-A01	Specialty Retail	978	B1	1B	Yes	10	100	1.5"	2"	1.8 cfm	55	2"	4"	4"	
B-2-029F-A01	Deferred	539	B1	1B	Yes	10	100	1.5"	2"	1.8 cfm	55	2"	4"	4"	
B-2-030C-A01	Specialty Retail	956	A1	1B	Yes	20	100	1.5"	2"	1.8 cfm	55	2"	4"	4"	
B-2-033C-A01	Food & Beverage	246	A3	1B	Yes	100	100	1.5"	2"	1.8 cfm	55	2"	4"	4"	Yes
B-2-033E-A01	Food & Beverage	4453	N/A	1B	Yes	E	SE	SE	SE	1.8 cfm	55	2"	4"	4"	Yes
B-2-034C-A01	Service *	145	A3	1B	Yes	10	100	1.5"	2"	1.8 cfm	55	2"	4"		
B-2-041D-A01	Food & Beverage	1755	B3	1B	Yes	100	350	4"	2-2.5"	1.8 cfm	55	2"	4"	4"	Yes
B-2-042D-A01	Food & Beverage	2035	B3	1B	Yes	100	300	3.5"	4"	1.8 cfm	55	2"	4"	4"	Yes
B-2-045E-A01	News	1530	B1	1B	Yes	75	200	2.5"	3"	1.8 cfm	55	2"	4"		
B-2-050C-A01	Deferred	855	A1	1B	Yes	10	100	1.5"	2"	1.8 cfm	55	2"	4"	4"	
B-2-054D-A01	Food & Beverage	1088	A1/A5	1B	Yes	100	200	2.5"	3"	1.8 cfm	55	2"	4"	4"	Yes
B-2-067D-A01	Specialty Retail	1049	A1/A5	1B	Yes	10	100	1.5"	2"	1.8 cfm	55	2"	4"	4"	
B-2-070D-A01	News	1040	A1/A5	1B	Yes	75	125	2"	2.5"	1.8 cfm	55	2"	4"	4"	
B-2-077C-A01	Food & Beverage	712	A1	1B	Yes	100	125	2"	2.5"	1.8 cfm	55	2"	4"	4"	Yes

Concessions Service Matrix- Terminal B (continued)

Concessions Service Matrix															
CONCESSION UNIT	CONCESSION TYPE	ARCHITECTURE			IT	ELECTRICAL				MECHANICAL		PLUMBING			
		Area (S.F.)	Design Condition	Type of Construction	ITS / Communication	Estimated Watts/SF	Estimated Service Size @ 480V, 3 Ph	Estimated Conduit Size	Installed Conduit Size	HVAC VAV Supply Air Volume	Supply Air Temp	Domestic Cold Water	Sanitary Sewer	Grease Waste	Natural Gas**
Terminal B Concourse Level															
B-2-077D-A01	Food & Beverage	1459	A2	1B	Yes	100	225	2.5"	3"	1.8 cfm	55	2"	4"	4"	Yes
B-2-078C-A01	Food & Beverage	698	A1	1B	Yes	75	100	1.5"	2"	1.8 cfm	55	2"	4"	4"	Yes
B-2-086C-A01	Deferred	942	A1	1B	Yes	50	100	1.5"	2"	1.8 cfm	55	2"	4"		
B-2-090D-A01	Specialty Retail	723	A1	1B	Yes	10	100	1.5"	2"	1.8 cfm	55	2"	4"		
B-2-091D-A01	Service *	202	A5	1B	Yes	10	100	1.5"	2"	1.8 cfm	55	2"	4"		
B-2-092B-L01	News	289	C2	1B	Yes	20	100	1.5"	2"	1.8 cfm	55	2"	4"		
B-2-092C-A01	Food & Beverage	863	A1	1B	Yes	100	150	2"	2.5"	1.8 cfm	55	2"	4"	4"	Yes
B-2-092D-A01	Specialty Retail	836	A1	1B	Yes	10	100	1.5"	2"	1.8 cfm	55	2"	4"		
B-2-093E-A01	Food & Beverage	1346	B1	1B	Yes	E	SE	SE	SE	1.8 cfm	55	2"	4"		
B-2-094C-A01	Specialty Retail	866	A1	1B	Yes	10	100	1.5"	2"	1.8 cfm	55	2"	4"		
B-2-095D-A01	Food & Beverage	3219	B2	1B	Yes	100	600	2-3.5"	2-4"	1.8 cfm	55	2"	4"	4"	Yes
B-2-098D-A01	Food & Beverage	1411	B5	1B	Yes		100		2"	1.8 cfm	55	2"	4"	4"	Yes
B-2-098E-A01	News	2008	B5	1B	Yes		100	1.5"	2"	1.8 cfm	55	2"	4"	4"	
B-2-104C-A01	Food & Beverage	653	A1	1B	Yes	75	100	1.5"	2"	1.8 cfm	55	2"	4"	4"	Yes
B-2-105C-A01	Specialty Retail	627	A1	1B	Yes	10	100	1.5"	2"	1.8 cfm	55	2"	4"		
B-2-106D-A01	Food & Beverage	3102	B2	1B	Yes	100	450	2-2.5"	2-3"	1.8 cfm	55	2"	4"	4"	Yes

Concessions Service Matrix- Terminal B (continued)

Concessions Service Matrix															
CONCESSION UNIT	CONCESSION TYPE	ARCHITECTURE			IT	ELECTRICAL				MECHANICAL		PLUMBING			
		Area (S.F.)	Design Condition	Type of Construction	ITS / Communication	Estimated Watts/SF	Estimated Service Size @ 480V, 3 Ph	Estimated Conduit Size	Installed Conduit Size	HVAC VAV Supply Air Volume	Supply Air Temp	Domestic Cold Water	Sanitary Sewer	Grease Waste	Natural Gas**
Terminal B Concourse Level															
B-2-109D-A01	Specialty Retail	802	B1	1B	Yes	75	100	1.5"	2"	1.8 cfm	55	2"	4"	4"	Yes
B-2-111C-A01	Food & Beverage	621	A3	1B	Yes		100		2"	1.8 cfm	55	2"	4"	4"	Yes
B-2-115D-A01	Deferred	1769	A2	1B	Yes	100	300	3.5"	4"	1.8 cfm	55	2"	4"	4"	
B-2-116C-A01	News	959	A1	1B	Yes		100	1.5"	2"	1.8 cfm	55	2"	4"	4"	
P-2-003R-A01	Food & Beverage	1199	N/A	1B	Yes		100	1.5"	2"	1.8 cfm	55	2"	4"	4"	Yes
P-2-002J-A01	News	393	N/A	1B	Yes		100	1.5"	2"	1.8 cfm	55	2"	4"		
S-2-006N-A01	News	502	N/A	1B	Yes		100	1.5"	2"	1.8 cfm	55	2"	4"	4"	

"E" Existing

"SE" Same as Existing

* Only Lighting and convenience receptacles provided.

** Regulator Performance to be determined according to Concession requirements.

PLACE HOLDER 11" X 17" PLAN

**PLACE HOLDER
11" X 17" PLAN**

9.0 EXHIBITS TERMINAL C

9.1 Provisions Summary- Terminal C

NOTE: Conditions listed below may not apply to all lease spaces. Refer to DFW Airport Provided Responsibility Matrix in section 9.2.

	Base Building	Tenant Improvements
STOREFRONT	Curtain wall side panels flanking neutral frame. Multi-bay tenants may elect to remove this DFW provided storefront from center column location. A formal request for deletion must be forwarded to DFW Concessions Department in writing prior to initial design submittal.	Build-out by tenant inside of neutral frame opening in accordance with the DFW Concessions Tenant Manual.
NEUTRAL FRAME	Consistent metal frame surround defining each storefront opening.	3/4" black reveal separating neutral frame from any tenant designed store elements.
DEMISING WALLS (TYPE 1) (All demising walls shown on Lease Exhibits are type 1 U.O.N.)	Refer to Lease Exhibits	Gypsum wallboard, insulation and finishes.
DEMISING WALL (TYPE 2)	Refer to Lease Exhibits	Gypsum wallboard, insulation and finishes. 60% of Type 2 demising walls can be translucent or open but cannot be open for pass-through circulation.
CEILINGS	Exposed structure.	By tenant to approved design criteria.
ACCOUSTICAL SOUND TRANSMISSION PROTECTION		In accordance with the DFW Concessions Tenant Manual.
FLOORS (TENANT INTERIOR)	Existing exposed concrete	Floor finishes in accordance with DFW Concessions Tenant Manual.
FLOORS (PUBLIC SEATING)	Terrazzo	Modification in accordance with DFW Concessions Tenant Manual.
FLOORS (PUBLIC UNWALLED AREAS)	Terrazzo	Modification in accordance with DFW Concessions Tenant Manual.
GUARDRAIL (F&B LOCATIONS DISPENSING SPIRITS ARE REQUIRED)		Refer to Lease Exhibits
ELECTRICAL	277 / 480 V power provided at dedicated ramp level electrical rooms. Empty conduit with pull cord terminated at lease line from common distribution panel. Switches in switchboard for connection of tenant services.	Panels, branch circuits, transformers, lighting, appliances, convenience outlets, equipment connections within tenant space.
EXHAUST DUCTS FOR KITCHEN HOODS, DISHWASHER, SMOKING (IF APPLICABLE)		Ductwork and rated enclosure from tenant equipment to roof mechanical wells. Roof mounted exhaust air fans.
HVAC	Main supply air duct taps to deliver 1.8 cfm per sq. ft.	VAV Box, grilles, registers, distribution ductwork and controls.

Provisions Summary- Terminal C (continued)

	Base Building	Tenant Improvements
FAN COIL UNIT		Fan Coil Unit and connections (if required) – grilles, registers, distribution ductwork, controls and condensate removal.
CHILLED AND HEATING WATER	Water distribution mains at ceiling with shut off valves and capped taps.	Chilled and heating water connections, control valves and piping to fan coil unit.
DOMESTIC WATER	Capped potable water connection provided below the concourse floor at the lease line with a valve at the main piping.	Connection to 2" main tap, backflow preventer, all distribution piping, fixtures, electrical storage type water heater as needed, drain piping from storage type water heater and connection to fixtures and appliances. Core drill to lease space trap primers to floor sinks and floor drains. Domestic water shall not be used for water cooled refrigeration units
SANITARY WASTE WATER	Below concourse floor, sanitary waste main with capped tap run to the lease line.	Connection to tap, core drill to lease space, upstream cleanouts, traps and fixtures.
GREASE WASTE WATER	Below concourse floor grease waste main piping with capped tap run to cooking concessions lease line.	Grease piping from appliances or interceptors within or below tenant space to the grease piping collection system, including heat trace, heat trace power, insulation and labels. If concession has a disposer, furnish a solids interceptor ahead of grease trap.
PLUMBING VENTS	Main vent up through roof, run to ceiling space of the concession lease line	Connections to main vent and install all vents in accordance with applicable codes.
YELLOW GREASE		Concessionaire to fill barrels, cart full barrels to storage room and collect clean barrels
NATURAL GAS	Medium pressure main natural gas piping across the roof with pressure regulators. Cooking concession low pressure gas tap connections run to lease line, penetrating through roof/wall into the ceiling space of concession lease line capped.	Connections to low pressure taps, connection to cooking appliances and provide manual shut off valves as required.
FIRE ALARM AND DETECTION / VOICE COMMUNICAITON SYSTEM	One 75-candela strobe for every 1600 sq. ft. of unobstructed space. In the event of a fire condition within the tenant spaces, or associated evacuation zones which is related to the tenant spaces, the strobe lights will flash and the appropriate pre-recorded and/or live voice messages will be distributed throughout the terminal. Activation of the tenant's system will generate a supervisory signal at the main fire alarm control panel. Speakers must be connected to the terminal's IED Paging System. Strobes must be connected to the Terminal's Fire Alarm System. PA/VE speaker systems are provided in revenue seating areas.	In accordance with the DFW Concessions Tenant Manual.

Provisions Summary- Terminal C (continued)

	Base Building	Tenant Improvements
FIRE PROTECTION SYSTEM	Upright and/or Pendent sprinklers on 1" sprigs or 1" drops.	Modifications to wet pipe sprinkler system to accommodate tenant design, including additional heads or increased pipe sizes must be in accordance with applicable codes and the DFW Concessions Tenant Manual. Tenant to provide special fire protection systems for hoods or other special requirements of the tenant including hand held extinguishers.
FIRE PROOFING	Base building fireproofing.	To meet fire ratings required by code.
ITS/COMMUNICATIONS	Empty conduit(s) with pull cord to pull box at demising wall or below floor from common IT/Communications closed distribution panel.	Media/Wiring to tenant panel to distribution panel. Tenant panel, all devices, equipment and distribution from tenant panel.

9.2 DFW Airport Provided Responsibility Matrix- Terminal C

Following are spread sheets that generally outline provisions by lease space number and tenant type. The specifics of these provisions will be outlined in the tenant lease agreement. All division of building utilities must be coordinated with adjacent tenants. **(Reference Section 2.0, "Design Conditions")**

9.2.1 - Building Construction Provisions																
SPACE NO.	TENANT MIX	Design Condition	ITS Communication	Electrical Conduit	HVAC Air Tap	Natural Gas	Chilled Water	Domestic Water Line	Sanitary Waste Water Line	Cooking Exhaust Right-of-way	Dishwashing Exhaust Right-of-way	Grease Waste Water	Plumbing vents Right-of-way	Base Building Fire Protection	Base Building Fire Alarm	General Notes
Concession Storage																

General Notes:

1. Terrazzo provided floor in open seating areas.
2. Airport ceiling system at open seating will include HVAC, Fire Protection, and lighting.

DFW Airport Provided Responsibility Matrix- Terminal C (continued)

Building Construction Provisions																
SPACE NO.	TENANT MIX	Design Condition	ITS Communication	Electrical Conduit	HVAC Air Tap	Natural Gas	Chilled Water	Domestic Water Line	Sanitary Waste Water Line	Cooking Exhaust Right-of-way	Dishwashing Exhaust Right-of-way	Grease Waste Water	Plumbing vents Right-of-way	Base Building Fire Protection	Base Building Fire Alarm	General Notes
Food & Beverage																

General Notes:

1. Terrazzo provided floor in open seating areas.
2. Airport ceiling system at open seating will include HVAC, Fire Protection, and lighting.

DFW Airport Provided Responsibility Matrix- Terminal C (continued)

Building Construction Provisions																
SPACE NO.	TENANT MIX	Design Condition	ITS Communication	Electrical Conduit	HVAC Air Tap	Natural Gas	Chilled Water	Domestic Water Line	Sanitary Waste Water Line	Cooking Exhaust Right-of-way	Dishwashing Exhaust Right-of-way	Grease Waste Water	Plumbing vents Right-of-way	Base Building Fire Protection	Base Building Fire Alarm	General Notes
News																

General Notes:

1. Terrazzo provided floor in open seating areas.
2. Airport ceiling system at open seating will include HVAC, Fire Protection, and lighting.

DFW Airport Provided Responsibility Matrix- Terminal C (continued)

Building Construction Provisions																
SPACE NO.	TENANT MIX	Design Condition	ITS Communication	Electrical Conduit	HVAC Air Tap	Natural Gas	Chilled Water	Domestic Water Line	Sanitary Waste Water Line	Cooking Exhaust Right-of-way	Dishwashing Exhaust Right-of-way	Grease Waste Water	Plumbing vents Right-of-way	Base Building Fire Protection	Base Building Fire Alarm	General Notes
Service																

General Notes:

1. Terrazzo provided floor in open seating areas.
2. Airport ceiling system at open seating will include HVAC, Fire Protection, and lighting.

DFW Airport Provided Responsibility Matrix- Terminal C (continued)

Building Construction Provisions																
SPACE NO.	TENANT MIX	Design Condition	ITS Communication	Electrical Conduit	HVAC Air Tap	Natural Gas	Chilled Water	Domestic Water Line	Sanitary Waste Water Line	Cooking Exhaust Right-of-way	Dishwashing Exhaust Right-of-way	Grease Waste Water	Plumbing vents Right-of-way	Base Building Fire Protection	Base Building Fire Alarm	General Notes
Specialty Retail																

General Notes:

1. Terrazzo provided floor in open seating areas.
2. Airport ceiling system at open seating will include HVAC, Fire Protection, and lighting.

9.3 Concessions Service Matrix- Terminal C

Concessions Service Matrix														
CONCESSION UNIT	CONCESSION TYPE	ARCHITECTURE			IT	ELECTRICAL				MECHANICAL		PLUMBING		
		Area (S.F.)	Design Condition	Type of Construction	ITS / Communication	Estimated Watts/SF	Estimated Service Size @ 480V, 3 Ph	Estimated Conduit Size	Installed Conduit Size	HVAC VAV Supply Air Volume	Supply Air Temp	Domestic Cold Water	Sanitary Sewer	Grease Waste
Terminal C Concourse Level														

Concessions Service Matrix- Terminal C (Continued)

Concessions Service Matrix															
CONCESSION UNIT	CONCESSION TYPE	ARCHITECTURE			IT	ELECTRICAL				MECHANICAL		PLUMBING			
		Area (S.F.)	Design Condition	Type of Construction	ITS / Communication	Estimated Watts/SF	Estimated Service Size @ 480V, 3 Ph	Estimated Conduit Size	Installed Conduit Size	HVAC VAV Supply Air Volume	Supply Air Temp	Domestic Cold Water	Sanitary Sewer	Grease Waste	Natural Gas**
Terminal C Concourse Level															

Concessions Service Matrix- Terminal C (Continued)

Concessions Service Matrix															
CONCESSION UNIT	CONCESSION TYPE	ARCHITECTURE			IT	ELECTRICAL			MECHANICAL			PLUMBING			
		Area (S.F.)	Design Condition	Type of Construction	ITS / Communication	Estimated Watts/SF	Estimated Service Size @ 480V, 3 Ph	Estimated Conduit Size	Installed Conduit Size	HVAC VAV Supply Air Volume	Supply Air Temp	Domestic Cold Water	Sanitary Sewer	Grease Waste	Natural Gas**
Terminal C Concourse Level															

* Only Lighting and convenience receptacles provided.

** Regulator Performance to be determined according to Concession requirements.

PLACE HOLDER 11" X 17" PLAN

PLACE HOLDER
11" X 17" PLAN

10.0 EXHIBITS TERMINAL E

10.1 Provisions Summary- Terminal E

NOTE: Conditions listed below may not apply to all lease spaces. Refer to DFW Airport Provided Responsibility Matrix in section 10.2.

	Base Building	Tenant Improvements
STOREFRONT	Curtain wall side panels flanking neutral frame. Multi-bay tenants may elect to remove this DFW provided storefront from center column location. A formal request for deletion must be forwarded to DFW Concessions Department in writing prior to initial design submittal.	Build-out by tenant inside of neutral frame opening in accordance with the DFW Concessions Tenant Manual.
NEUTRAL FRAME	Consistent metal frame surround defining each storefront opening.	3/4" black reveal separating neutral frame from any tenant designed store elements.
DEMISING WALLS (TYPE 1) (All demising walls shown on Lease Exhibits are type 1 U.O.N.)	Refer to Lease Exhibits	Gypsum wallboard, insulation and finishes.
DEMISING WALL (TYPE 2)	Refer to Lease Exhibits	Gypsum wallboard, insulation and finishes. 60% of Type 2 demising walls can be translucent or open but cannot be open for pass-through circulation.
CEILINGS	Exposed structure.	By tenant to approved design criteria.
ACCOUSTICAL SOUND TRANSMISSION PROTECTION		In accordance with the DFW Concessions Tenant Manual.
FLOORS (TENANT INTERIOR)	Existing exposed concrete	Floor finishes in accordance with DFW Concessions Tenant Manual.
FLOORS (PUBLIC SEATING)	Terrazzo	Modification in accordance with DFW Concessions Tenant Manual.
FLOORS (PUBLIC UNWALLED AREAS)	Terrazzo	Modification in accordance with DFW Concessions Tenant Manual.
GUARDRAIL (F&B LOCATIONS DISPENSING SPIRITS ARE REQUIRED)		Refer to Lease Exhibits
ELECTRICAL	277 / 480 V power provided at dedicated ramp level electrical rooms. Empty conduit with pull cord terminated at lease line from common distribution panel. Switches in switchboard for connection of tenant services.	Panels, branch circuits, transformers, lighting, appliances, convenience outlets, equipment connections within tenant space.
EXHAUST DUCTS FOR KITCHEN HOODS, DISHWASHER, SMOKING (IF APPLICABLE)		Ductwork and rated enclosure from tenant equipment to roof mechanical wells. Roof mounted exhaust air fans.
HVAC	Main supply air duct taps to deliver 1.8 cfm per sq. ft.	VAV Box, grilles, registers, distribution ductwork and controls.

Provisions Summary- Terminal E (continued)

	Base Building	Tenant Improvements
FAN COIL UNIT		Fan Coil Unit and connections (if required) – grilles, registers, distribution ductwork, controls and condensate removal.
CHILLED AND HEATING WATER	Water distribution mains at ceiling with shut off valves and capped taps.	Chilled and heating water connections, control valves and piping to fan coil unit.
DOMESTIC WATER	Capped potable water connection provided below the concourse floor at the lease line with a valve at the main piping.	Connection to 2" main tap, backflow preventer, all distribution piping, fixtures, electrical storage type water heater as needed, drain piping from storage type water heater and connection to fixtures and appliances. Core drill to lease space trap primers to floor sinks and floor drains. Domestic water shall not be used for water cooled refrigeration units
SANITARY WASTE WATER	Below concourse floor, sanitary waste main with capped tap run to the lease line.	Connection to tap, core drill to lease space, upstream cleanouts, traps and fixtures.
GREASE WASTE WATER	Below concourse floor grease waste main piping with capped tap run to cooking concessions lease line.	Grease piping from appliances or interceptors within or below tenant space to the grease piping collection system, including heat trace, heat trace power, insulation and labels. If concession has a disposer, furnish a solids interceptor ahead of grease trap.
PLUMBING VENTS	Main vent up through roof, run to ceiling space of the concession lease line	Connections to main vent and install all vents in accordance with applicable codes.
YELLOW GREASE		Concessionaire to fill barrels, cart full barrels to storage room and collect clean barrels
NATURAL GAS	Medium pressure main natural gas piping across the roof with pressure regulators. Cooking concession low pressure gas tap connections run to lease line, penetrating through roof/wall into the ceiling space of concession lease line capped.	Connections to low pressure taps, connection to cooking appliances and provide manual shut off valves as required.
FIRE ALARM AND DETECTION / VOICE COMMUNICAITON SYSTEM	One 75-candela strobe for every 1600 sq. ft. of unobstructed space. In the event of a fire condition within the tenant spaces, or associated evacuation zones which is related to the tenant spaces, the strobe lights will flash and the appropriate pre-recorded and/or live voice messages will be distributed throughout the terminal. Activation of the tenant's system will generate a supervisory signal at the main fire alarm control panel. Speakers must be connected to the terminal's IED Paging System. Strobes must be connected to the Terminal's Fire Alarm System. PA/VE speaker systems are provided in revenue seating areas.	In accordance with the DFW Concessions Tenant Manual.

Provisions Summary- Terminal E (continued)

	Base Building	Tenant Improvements
FIRE PROTECTION SYSTEM	Upright and/or Pendent sprinklers on 1" sprigs or 1" drops.	Modifications to wet pipe sprinkler system to accommodate tenant design, including additional heads or increased pipe sizes must be in accordance with applicable codes and the DFW Concessions Tenant Manual. Tenant to provide special fire protection systems for hoods or other special requirements of the tenant including hand held extinguishers.
FIRE PROOFING	Base building fireproofing.	To meet fire ratings required by code.
ITS/COMMUNICATIONS	Empty conduit(s) with pull cord to pull box at demising wall or below floor from common IT/Communications closed distribution panel.	Media/Wiring to tenant panel to distribution panel. Tenant panel, all devices, equipment and distribution from tenant panel.

10.2 DFW Airport Provided Responsibility Matrix- Terminal E

Following are spread sheets that generally outline provisions by lease space number and tenant type. The specifics of these provisions will be outlined in the tenant lease agreement. All division of building utilities must be coordinated with adjacent tenants. **(Reference Section 2.0, "Design Conditions")**

10.2.1 - Building Construction Provisions																
SPACE NO.	TENANT MIX	Design Condition	ITS Communication	Electrical Conduit	HVAC Air Tap	Natural Gas	Chilled Water	Domestic Water Line	Sanitary Waste Water Line	Cooking Exhaust Right-of-way	Dishwashing Exhaust Right-of-way	Grease Waste Water	Plumbing vents Right-of-way	Base Building Fire Protection	Base Building Fire Alarm	General Notes
Concession Storage/Deferred Concession/Office																
E-2-008C-A01	Concession Storage	N/A	X	X	X		X	X	X					X	X	
E-2-029F-A01	Deferred Concessions	B1	X	X	X		X	X	X					X	X	
E-2-069E-A01	Concession Office	N/A	X	X	X		X	X	X					X	X	
E-2-070E-A01	Concession Storage	N/A	X	X	X		X	X	X					X	X	
E-2-096F-A01	Deferred Concessions	B1	X	X	X		X	X	X					X	X	
E-2-097C-A01	Service	A1	X	X	X		X	X	X					X	X	
E-2-128E-A01	Deferred Concessions	A3	X	X	X		X	X	X					X	X	
ES-1-005E-A01	Concessions Storage	N/A	X	X	X		X	X	X					X	X	
ES-1-006D-A01	Concessions Storage	N/A	X	X	X		X	X	X					X	X	
ES-1-016B-A01	Concessions Storage	N/A	X	X	X		X	X	X					X	X	

General Notes:

1. Terrazzo provided floor in open seating areas.
2. Airport ceiling system at open seating will include HVAC, Fire Protection, and lighting.

DFW Airport Provided Responsibility Matrix- Terminal E (continued)

Building Construction Provisions																
SPACE NO.	TENANT MIX	Design Condition	ITS Communication	Electrical Conduit	HVAC Air Tap	Natural Gas	Chilled Water	Domestic Water Line	Sanitary Waste Water Line	Cooking Exhaust Right-of-way	Dishwashing Exhaust Right-of-way	Grease Waste Water	Plumbing vents Right-of-way	Base Building Fire Protection	Base Building Fire Alarm	General Notes
Food & Beverage																
E-2-012C-A01	Cafe/Bar	A1	X	X	X	X	X	X	X	X	X	X	X	X	X	
E-2-021C-A01	Walk-away	A2	X	X	X	X	X	X	X	X		X	X	X	X	
E-2-021D-A01	Walk-away	A1	X	X	X	X	X	X	X	X		X	X	X	X	
E-2-031E-A01	Table Service	B1	X	X	X	X	X	X	X	X	X	X	X	X	X	
E-2-045E-A01	Quick Service	B1	X	X	X	X	X	X	X	X	X	X	X	X	X	
E-2-055D-A01	Quick Service	A1 / A5	X	X	X	X	X	X	X	X	X	X	X	X	X	
E-2-056C-A01	TBD	A1 / A5	X	X	X	X	X	X	X	X	X	X	X	X	X	
E-2-079D-A01	Table Service	N/A	X	X	X	X	X	X	X	X	X	X	X	X	X	
E-2-090D-A01	Walk-away	C1	X	X	X	X	X	X	X	X		X	X	X	X	
E-2-098D-A01	Table Service	B2	X	X	X	X	X	X	X	X	X	X	X	X	X	
E-2-107E-A01	Quick Service	B3	X	X	X	X	X	X	X	X	X	X	X	X	X	
E-2-108F-A01	Quick Service	B3	X	X	X	X	X	X	X	X	X	X	X	X	X	
E-2-115D-A01	Walk-away	A5	X	X	X	X	X	X	X	X		X	X	X	X	
E-2-124D-A01	Quick Service	N/A	X	X	X	X	X	X	X	X	X	X	X	X	X	

General Notes:

1. Terrazzo provided floor in open seating areas.
2. Airport ceiling system at open seating will include HVAC, Fire Protection, and lighting.

DFW Airport Provided Responsibility Matrix- Terminal E (continued)

Building Construction Provisions																
SPACE NO.	TENANT MIX	Design Condition	ITS Communication	Electrical Conduit	HVAC Air Tap	Natural Gas	Chilled Water	Domestic Water Line	Sanitary Waste Water Line	Cooking Exhaust Right-of-way	Dishwashing Exhaust Right-of-way	Grease Waste Water	Plumbing vents Right-of-way	Base Building Fire Protection	Base Building Fire Alarm	General Notes
News																
E-2-022B-L01	News & Books	A6	X	X	X		X	X	X		X	X	X	X	X	
E-2-029E-A01	News & Books	B1	X	X	X		X	X	X		X	X	X	X	X	
E-2-054D-A01	News & Books	A1	X	X	X		X	X	X			X	X	X	X	
E-2-063B-L01	News & Books	C2	X	X	X		X	X	X			X	X	X	X	
E-2-095D-A01	News & Books	B1 / A5	X	X	X		X	X	X		X	X	X	X	X	
E-2-109C-A01	Specialty Retail	A1	X	X	X		X	X	X		X	X	X	X	X	
E-2-122C-A02	News & Books	N/A	X	X	X		X	X	X		X	X	X	X	X	
E-2-125B-L01	News & Books	C2	X	X	X		X	X	X		X	X	X	X	X	

General Notes:

1. Terrazzo provided floor in open seating areas.
2. Airport ceiling system at open seating will include HVAC, Fire Protection, and lighting.

DFW Airport Provided Responsibility Matrix- Terminal E (continued)

Building Construction Provisions																
SPACE NO.	TENANT MIX	Design Condition	ITS Communication	Electrical Conduit	HVAC Air Tap	Natural Gas	Chilled Water	Domestic Water Line	Sanitary Waste Water Line	Cooking Exhaust Right-of-way	Dishwashing Exhaust Right-of-way	Grease Waste Water	Plumbing vents Right-of-way	Base Building Fire Protection	Base Building Fire Alarm	General Notes
Service																
E-2-023C-A01	Shoe Shine	A5	X	X	X			X	X							
E-2-083D-A01	Shoe Shine	A5	X	X	X			X	X							
E-2-097-C-A01	Spa	A1														

General Notes:

1. Terrazzo provided floor in open seating areas.
2. Airport ceiling system at open seating will include HVAC, Fire Protection, and lighting.

DFW Airport Provided Responsibility Matrix- Terminal E (continued)

Building Construction Provisions																
SPACE NO.	TENANT MIX	Design Condition	ITS Communication	Electrical Conduit	HVAC Air Tap	Natural Gas	Chilled Water	Domestic Water Line	Sanitary Waste Water Line	Cooking Exhaust Right-of-way	Dishwashing Exhaust Right-of-way	Grease Waste Water	Plumbing vents Right-of-way	Base Building Fire Protection	Base Building Fire Alarm	General Notes
Specialty Retail																
E-2-032D-A01	Entertainment & Consumer Electronics	A1	X	X	X			X	X					X	X	
E-2-046D-A01	Apparel & Accessories	A1 / A5	X	X	X			X	X					X	X	
E-2-068D-A01	Apparel & Accessories	A1	X	X	X			X	X					X	X	
E-2-069D-A01	Entertainment & Consumer Electronics	A1	X	X	X			X	X					X	X	
E-2-085C-A01	TBD	A3	X	X	X			X	X					X	X	
E-2-100D-A01	TBD	A1	X	X	X		X	X	X					X	X	
E-2-109C-A01	Packaged Foods	A1	X	X	X		X	X	X					X	X	
E-2-111E-A01	Entertainment & Consumer Electronics	A5	X	X	X			X	X					X	X	
E-2-116D-A01	Gifts/Specialty	A1	X	X	X		X	X	X					X	X	

General Notes:

1. Terrazzo provided floor in open seating areas.
2. Airport ceiling system at open seating will include HVAC, Fire Protection, and lighting.

10.3 Concessions Service Matrix- Terminal E

Concessions Service Matrix															
CONCESSION UNIT	CONCESSION TYPE	ARCHITECTURE			IT	ELECTRICAL				MECHANICAL		PLUMBING			
		Area (S.F.)	Design Condition	Type of Construction	ITS / Communication	Estimated Watts/SF	Estimated Service Size @ 480V, 3 Ph	Estimated Conduit Size	Installed Conduit Size	HVAC VAV Supply Air Volume	Supply Air Temp	Domestic Cold Water	Sanitary Sewer	Grease Waste	Natural Gas**
Terminal E Concourse Level															
E-2-008C-A01	Concession Storage	168	N/A	1B	Yes	10	100	1.5"	2"	1.8 cfm	55	2"	4"	4"	Yes
E-2-012C-A01	Food & Beverage	933	A1	1B	Yes	100	100	2"	2"	1.8 cfm	55	2"	4"	4"	Yes
E-2-021C-A01	Food & Beverage	1393	A2	1B	Yes	100	100	2"	2"	1.8 cfm	55	2"	4"	4"	Yes
E-2-021D-A01	Food & Beverage	453	A1	1B	Yes	50	100	1.5"	2"	1.8 cfm	55	2"	4"	4"	Yes
E-2-022B-L01	News	241	A6	1B	Yes	50	100	1.5"	2"	1.8 cfm	55	2"	4"		
E-2-023C-A01	Service *	210	A5	1B	Yes	10	100	1.5"	2"	1.8 cfm	55	2"	4"		
E-2-029E-A01	News	1526	B1	1B	Yes	75	100	2"	2"	1.8 cfm	55	2"	4"		
E-2-029F-A01	Deferred Concession	551	B1	1B		20	100	1.5"	2"	1.8 cfm	55	2"	4"		
E-2-031E-A01	Food & Beverage	4640	B2	1B	Yes	100	100	(2) 4"	(2) 4"	1.8 cfm	55	2"	4"	4"	Yes
E-2-032D-A01	Specialty Retail	728	A1	1B	Yes	20	100	1.5"	2"	1.8 cfm	55	2"	4"	4"	
E-2-045E-A01	Food & Beverage	1744	B1	1B	Yes	100	100	4"	4"	1.8 cfm	55	2"	4"	4"	Yes
E-2-045F-A01	Concession Office	634													
E-2-046D-A01	Specialty Retail	1391	A1/A5	1B	Yes	10	100	1.5"	2"	1.8 cfm	55	2"	4"	4"	
E-2-054D-A01	News	1373	A1	1B	Yes	75	100	2"	2"	1.8 cfm	55	2"	4"		
E-2-055D-A01	Food & Beverage	2052	A1/A5	1B	Yes	100	100	4"	4"	1.8 cfm	55	2"	4"	4"	Yes
E-2-056C-A01	Food & Beverage	547	A1/A5	1B	Yes	100	100	1.5"	2"	1.8 cfm	55	2"	4"	4"	Yes
E-2-063B-L01	News	391	C2	1B	Yes	50	100	1.5"	2"	1.8 cfm	55	2"	4"		
E-2-068D-A01	Specialty Retail	631	A1	1B	Yes	10	100	1.5"	2"	1.8 cfm	55	2"	4"	4"	

Concessions Service Matrix- Terminal E (continued)

Concessions Service Matrix															
CONCESSION UNIT	CONCESSION TYPE	ARCHITECTURE			IT	ELECTRICAL				MECHANICAL		PLUMBING			
		Area (S.F.)	Design Condition	Type of Construction	ITS / Communication	Estimated Watts/SF	Estimated Service Size @ 480V, 3 Ph	Estimated Conduit Size	Installed Conduit Size	HVAC VAV Supply Air Volume	Supply Air Temp	Domestic Cold Water	Sanitary Sewer	Grease Waste	Natural Gas**
Terminal E Concourse Level															
E-2-069D-A01	Specialty Retail	844	A1	1B	Yes	20	100	1.5"	2"	1.8 cfm	55	2"	4"	4"	
E-2-069E-A01	Concession Office	447	N/A	1B	Yes	100	100	1.5"	2"	1.8 cfm	55	2"	4"		
E-2-070E-A01	Concessions Storage	469													
E-2-079D-A01	Food & Beverage	5177	N/A	1B	Yes	EXISTING TO REMAIN				1.8 cfm	55	2"	4"	4"	Yes
E-2-083D-A01	Service*	196	A5	1B	Yes	10	100	1.5"	2"	1.8 cfm	55	2"	4"		
E-2-085C-A01	Specialty Retail	311	A3	1B	Yes	20	100	1.5"	2"	1.8 cfm	55	2"	4"	4"	
E-2-090D-A01	Food & Beverage	704	C1	1B	Yes	50	100	1.5"	2"	1.8 cfm	55	2"	4"	4"	Yes
E-2-095D-A01	News	1428	B1/A5	1B	Yes	75	175	2"	2"	1.8 cfm	55	2"	4"		
E-2-096F-A01	Deferred Concession - 2020	661	B1	1B		20	100	1.5"	2"	1.8 cfm	55	2"	4"		
E-2-097C-A01	Service	576	A1	1B		75	100	1.5"	2"	1.8 cfm	55	2"	4"		
E-2-098D-A01	Concessions Storage	3907	B2	1B	Yes	100	600	(2) 4"	(2) 4"	1.8 cfm	55	2"	4"	4"	Yes
E-2-100D-A01	Specialty Retail	1424	A1	1B	Yes	10	100	1.5"	2"	1.8 cfm	55	2"	4"		
E-2-107E-A01	Food & Beverage	3588	B3	1B	Yes	100	600	(2) 4"	(2) 4"	1.8 cfm	55	2"	4"	4"	Yes
E-2-108F-A01	Food & Beverage	3618	B3	1B	Yes	100	600	(2) 4"	(2) 4"	1.8 cfm	55	2"	4"	4"	Yes
E-2-109C-A01	Specialty Retail	910	A1	1B	Yes	10	100	1.5"	2"	1.8 cfm	55	2"	4"		
E-2-111E-A01	Specialty Retail	413	A5	1B	Yes	20	100	1.5"	2"	1.8 cfm	55	2"	4"		
E-2-115D-A01	Food & Beverage	837	A5	1B	Yes	50	100	1.5"	2"	1.8 cfm	55	2"	4"	4"	Yes
E-2-116D-A01	Specialty Retail	731	A1	1B	Yes	10	100	1.5"	2"	1.8 cfm	55	2"	4"		

Concessions Service Matrix- Terminal E (continued)

Concessions Service Matrix															
CONCESSION UNIT	CONCESSION TYPE	ARCHITECTURE			IT	ELECTRICAL				MECHANICAL		PLUMBING			
		Area (S.F.)	Design Condition	Type of Construction	ITS / Communication	Estimated Watts/SF	Estimated Service Size @ 480V, 3 Ph	Estimated Conduit Size	Installed Conduit Size	HVAC VAV Supply Air Volume	Supply Air Temp	Domestic Cold Water	Sanitary Sewer	Grease Waste	Natural Gas**
Terminal E Concourse Level															
E-2-122C-A02	News	874	N/A	1B	Yes	10	100	1.5"	2"	1.8 cfm	55	2"	4"		
E-2-124D-A01	Food & Beverage	2065	N/A	1B	Yes	100	350	4"	4"	1.8 cfm	55	2"	4"	4"	Yes
E-2-125B-L01	News	299	C3	1B	Yes	50	100	1.5"	2"	1.8 cfm	55	2"	4"		
E-2-128E-A01	Deferred Concession - 2020	463	A3	1B		50	100	1.5"	2"	1.8 cfm	55	2"	4"		
ES-1-005E-A01	Concessions Storage	152	N/A	1B	Yes		100		2"	1.8cfm	55	2"	4"		
ES-1-006D-A01	Concessions Storage	503	N/A	1B	Yes		100		2"	1.8cfm	55	2"	4"		
ES-1-016B-A01	Concessions Storage	554	N/A	1B	Yes		100		2"	1.8cfm	55	2"	4"		

* Only Lighting and convenience receptacles provided.

** Regulator Performance to be determined according to Concession requirements.

PLACE HOLDER
11" X 17" PLAN

PLACE HOLDER
11" X 17" PLAN

11.0 Schedules

Schedules are to be submitted as a part of the Design Review and Code Submittal. (Reference Sections 3.8 Mechanical, Electrical and Plumbing Requirements, 5.1.1 Schematic design Submittal-35% and 5.1.2 Contract Documents Submittal-95%)

THIS PAGE LEFT INTENTIONALLY BLANK

11.1 Heat Loss Schedule

Project:	
Tenant:	
Type of Store:	Area: X = sq. ft.

	Item	Room: Number							
		Name							
		1	Area (sq. ft.)						
		2	Ceiling height (ft.)						
3	Volume (cu. ft.)								
EXTERIOR LOSSES			Factor	Quantity	BTUH	Quantity	BTUH	Quantity	BTUH
C D Y A C Y L E	4	Roof							
	5	Wall							
	6	Glass							
	7	Infiltration							
	8								
	9	Sub Total (4 thru 8)							
N C I Y G C H L T E	10	Roof							
	11	Wall							
	12	Glass							
	13								
	14	Sub Total (10 thru 13)							
INTERIOR GAINS									
D C A Y Y C	15	Lights (25% Credit)	0.25						
	16	Other							
	17	Sub Total (15 + 16)							
NET HEAT LOSS									
C D Y A C Y L E	18	Room Load (9 less 17)							
	19	Average Room Load per sq. ft. (lt. 18/lt. 1)							
	20	Total Tenant Area (Sum of Item 1)							
	21	Tenant Grand Total Load (Sum of lt. 18)							
	22	Avg. Tenant Load per sq. ft. (lt. 21/20)							
N C G Y T C	23	Avg. Room Load per sq. ft. (lt. 14/1)							
	24	Tenant Grand Total Load (Sum of lt. 14)							
	25	Avg. Tenant Load per sq. ft. (lt. 24/lt. 20)							

- Notes:
1. Refer to Design Criteria for design conditions.
 2. Overall Coefficient of Heat Transfer ("U" Value) of Tenant Wall is dependent on tenant's inside wall construction.
 3. For Tenant's Load in Watt per sq. ft., divide appropriate "BTUH" column by 3.413.

THIS PAGE LEFT INTENTIONALLY BLANK

11.2 Heat Gain Schedule

Project:	
Tenant:	
Type of Store:	Area: X = sq. ft.

	Item	Room: Number						
		Name						
		1	Area (sq. ft.)					
		2	Ceiling height (ft.)					
3	Volume (cu. ft.)							
EXTERIOR LOSSES		Factor	Quantity	BTUH	Quantity	BTUH	Quantity	BTUH
C D A C Y L E	4	Roof						
	5	Wall						
	6	Glass						
	7	Infiltration						
	8							
	9	Sub Total (4 thru 8)						
N C I Y G C H L T E	10	Roof						
	11	Wall						
	12	Glass						
	13							
	14	Sub Total (10 thru 13)						
INTERIOR GAINS								
D C A Y Y C	15	Lights (25% Credit)	0.25					
	16	Other						
	17	Sub Total (15 + 16)						
NET HEAT LOSS								
C D Y A C Y L E	18	Room Load (9 less 17)						
	19	Average Room Load per sq. ft. (lt. 18/lt. 1)						
	20	Total Tenant Area (Sum of Item 1)						
	21	Tenant Grand Total Load (Sum of lt. 18)						
	22	Avg. Tenant Load per sq. ft. (lt. 21/20)						
N C G Y T C	23	Avg. Room Load per sq. ft. (lt. 14/1)						
	24	Tenant Grand Total Load (Sum of lt. 14)						
	25	Avg. Tenant Load per sq. ft. (lt. 24/lt. 20)						

- Notes:
1. Refer to Design Criteria for design conditions.
 2. Overall Coefficient of Heat Transfer ("U" Value) of Tenant Wall is dependent on tenant's inside wall construction.
 3. For Tenant's Load in Watt per sq. ft., divide appropriate "BTUH" column by 3.413.

THIS PAGE LEFT INTENTIONALLY BLANK

11.3 Electrical Review Schedule

Project: _____			
Tenant: _____			
Type of Store: _____	Area: _____	X _____	= _____ sq. ft.
Circuit Breaker installed in Owner's Distribution Panel to Serve Tenant:		Size: _____	
Frame: _____	AIC Rating: _____	Voltage: 277/480, Poles: 3	

Service Conductors/Conduit from Owner's Distribution Panel to Tenant Distribution Panel:

Conductor Sizes: Phase: _____ Neutral: _____ Ground: _____ Conduit Size: _____

Loads	Connected KVA	Design Factor (%)	Design KVA
Lighting		125	
Receptacles		**	
Transformers		125	
Motors		125 (largest) + 100	
Heating		*	
Air Conditioning		*	
Miscellaneous		100	
Spares & Spaces		100	
Kitchen		(See NEC)	
Hot Water Heater		125	
Totals: _____ KVA _____ KVA _____ VA/SF _____ VA/SF			
* Largest Coincident Load A/C, Heating ** First 10 KVA @ 100% (Remainder @ 50%)			

Tenant Furnished Equipment Sizes			
Main C/B in Tenant Distribution Panel (TDP): _____		Size: _____	Frame: _____
		Trip: _____	AIC Rating: _____
Step Down Transformer: KVA: _____ Secondary Voltage: _____ Phase: _____			

3 Phase Fault Current Data	
Panelboard: _____	Max. Avail. 3 Phase Fault Current: _____
Panelboard: _____	Max. Avail. 3 Phase Fault Current: _____
Panelboard: _____	Max. Avail. 3 Phase Fault Current: _____
Panel: _____	Max. Avail. 3 Phase Fault Current: _____

THIS PAGE LEFT INTENTIONALLY BLANK

11.4 DFW International Airport ETAM Department Vent/Hood Data Form

INSTRUCTIONS:

Concessionaire Contractor shall complete this form as part of the Concessions Department TCO final-phase requirements. Concessionaire Contractor shall complete the Location, Exhaust and Vent/Hood sections (blue sections) of this form, and attach any additional information (e.g., manuals) related to **each** vent/hood system included in this form. If the F&B Tenant location does not have a vent/hood system, the Concessionaire Contractor shall indicate such in the Location Exhaust Information comments section. **Concessionaire Contractor must sign this form and provide license information. Failure to include this information will delay the F&B Tenant's TCO approval process.** Once completed, Concessions Department staff shall forward this form to the ETAM Department's Senior Compliance Analyst at cjackson@dfwairport.com.

ETAM Facilities Services Coordinator shall complete the gold section of this form regarding cleaning frequency. After completion, forward form to the ETAM Systems Performance Group.

ETAM Systems Performance Group shall input all necessary information related to the vent/hood system into INFOR EAM, and complete the green section of this form.

All recorded data in the blue section should be typed to ensure legibility.

General location Information					
F&B Tenant Name:		Terminal: Terminal Level:		Concessions Unit ID Number:	
Column Line:		Grid Line:		Gate Area:	
F&B Tenant Contact:		Telephone:		Date Form Completed:	
Location exhaust Information					
	number of exhaust duct assembly		number of hoods connected to exhaust duct assembly		exhaust duct linear footage
	number of make-up air fans		number of make-up air fan ducts		make-up air fan duct linear footage
comments (E.g., Please note all optional/upgraded features added):					
Type I Vent/Hood (check All applicable information)					
<input type="checkbox"/>	island	<input type="checkbox"/>	single island	<input type="checkbox"/>	Double island
<input type="checkbox"/>	wall or back shelf	<input type="checkbox"/>	end-to-end	<input type="checkbox"/>	fire suppression
<input type="checkbox"/>	vapor-proof lights	<input type="checkbox"/>	back-splashes	<input type="checkbox"/>	griddle
<input type="checkbox"/>	fryer	<input type="checkbox"/>	charbroiler	<input type="checkbox"/>	Wok
	Number of grease filters		number of grease cups		number of exhaust air fans
Manufacturer (e.g., captive aire):		model number:		serial number:	
comments (E.g., Please note all optional/upgraded features added):					

Type I Vent/Hood (check all applicable information)					
<input type="checkbox"/>	island	<input type="checkbox"/>	single island	<input type="checkbox"/>	Double island
<input type="checkbox"/>	wall or back shelf	<input type="checkbox"/>	end-to-end	<input type="checkbox"/>	fire suppression
<input type="checkbox"/>	vapor-proof lights	<input type="checkbox"/>	back-splashes	<input type="checkbox"/>	griddle
<input type="checkbox"/>	fryer	<input type="checkbox"/>	charbroiler	<input type="checkbox"/>	Wok
	Number of grease filters		number of grease cups		number of exhaust air fans
Manufacturer (e.g., captive aire):		model number:		serial number:	
comments (E.g., Please note all optional/upgraded features added):					

TYPE II VENT/Hood (check all applicable information)					
<input type="checkbox"/>	island	<input type="checkbox"/>	single island	<input type="checkbox"/>	Double island
<input type="checkbox"/>	wall or back shelf	<input type="checkbox"/>	end-to-end	<input type="checkbox"/>	fire suppression
<input type="checkbox"/>	vapor-proof lights	<input type="checkbox"/>	back-splashes	<input type="checkbox"/>	Oven
	Number of ovens				number of exhaust air fans
Manufacturer (e.g., captive aire):		model number:		serial number:	
comments (E.g., Please note all optional/upgraded features added):					
Concessionaire contractor information					
Printed Name:		Signature:		License Number:	

Type II Vent/Hood (check ALL applicable information)

<input type="checkbox"/>	island	<input type="checkbox"/>	single island	<input type="checkbox"/>	Double island
<input type="checkbox"/>	wall or back shelf	<input type="checkbox"/>	end-to-end	<input type="checkbox"/>	fire suppression
<input type="checkbox"/>	vapor-proof lights	<input type="checkbox"/>	back-splashes	<input type="checkbox"/>	Oven
	Number of ovens				number of exhaust air fans
Manufacturer (e.g., captive aire):		model number:		serial number:	
comments (E.g., Please note all optional/upgraded features added):					

Concessionaire contractor information

Printed Name:	Signature:	License Number:
---------------	------------	-----------------

ETAM Cleaning frequency

Type I	serial number:						
<input type="checkbox"/>	Daily	<input type="checkbox"/>	Weekly	<input type="checkbox"/>	Bi-weekly	<input type="checkbox"/>	Monthly
<input type="checkbox"/>	Bi-Monthly	<input type="checkbox"/>	Quarterly	<input type="checkbox"/>	Semi-Annual	<input type="checkbox"/>	Annually
Due Date (E.g., Day, Date, Week, Month):		Start Date (I.e., Date first PM is due):		Department (E.g., E.TERM.MEPS, D.TERM.CUST)			
Type I	serial number:						
<input type="checkbox"/>	Daily	<input type="checkbox"/>	Weekly	<input type="checkbox"/>	Bi-weekly	<input type="checkbox"/>	Monthly
<input type="checkbox"/>	Bi-Monthly	<input type="checkbox"/>	Quarterly	<input type="checkbox"/>	Semi-Annual	<input type="checkbox"/>	Annually
Due Date (E.g., Day, Date, Week, Month):		Start Date (I.e., Date first PM is due):		Department (E.g., E.TERM.MEPS, D.TERM.CUST)			

ETAM Cleaning frequency

Type II		serial number:					
<input type="checkbox"/>	Daily	<input type="checkbox"/>	Weekly	<input type="checkbox"/>	Bi-weekly	<input type="checkbox"/>	Monthly
<input type="checkbox"/>	Bi-Monthly	<input type="checkbox"/>	Quarterly	<input type="checkbox"/>	Semi-Annual	<input type="checkbox"/>	Annually
Due Date (E.g., Day, Date, Week, Month):			Start Date (I.e., Date first PM is due):		Department (E.g., E.TERM.MEPS, D.TERM.CUST)		
Type II		serial number:					
<input type="checkbox"/>	Daily	<input type="checkbox"/>	Weekly	<input type="checkbox"/>	Bi-weekly	<input type="checkbox"/>	Monthly
<input type="checkbox"/>	Bi-Monthly	<input type="checkbox"/>	Quarterly	<input type="checkbox"/>	Semi-Annual	<input type="checkbox"/>	Annually
Due Date (E.g., Day, Date, Week, Month):			Start Date (I.e., Date first PM is due):		Department (E.g., E.TERM.MEPS, D.TERM.CUST)		

ETAM SYSTEM PERFORMANCE GROUP

Date Received:		Date Input in Infor EAM:	
Input by (printed name):		Signature:	
OTHER INFORMATION TO NOTE (EXPLAIN):			

END OF FORM

12.0 Specifications

Specifications are included to maintain continuity with-in all tenant spaces.

THIS PAGE LEFT INTENTIONALLY BLANK

SECTION 05 73 00 DECORATIVE METAL RAILINGS

PART 1 - GENERAL

1.1 SUMMARY

A. Section Includes:

1. Stainless-steel decorative railings with glass- or metal-infill panels.

1.2 REFERENCES

A. American Architectural Manufacturers Association

1. AAMA Aluminum Curtain Wall Series No. 12: Structural Properties of Glass

B. American Welding Society

1. AWS D1.6: Structural Welding Code - Stainless Steel

C. ASTM International

1. ASTM A 240/A 240M: Specification for Chromium and Chromium-Nickel Stainless Steel Plate, Sheet, and Strip for Pressure Vessels and for General Applications
2. ASTM A 276: Specification for Stainless Steel Bars and Shapes
3. ASTM A 312/A 312M: Specification for Seamless, Welded, and Heavily Cold Worked Austenitic Stainless Steel Pipes
4. ASTM A 554: Specification for Welded Stainless Steel Mechanical Tubing
5. ASTM A 666: Specification for Annealed or Cold-Worked Austenitic Stainless Steel Sheet, Strip, Plate, and Flat Bar
6. ASTM A 743/A 743M: Specification for Castings, Iron-Chromium, Iron-Chromium-Nickel, Corrosion-Resistant, for General Application
7. ASTM B 633: Specification for Electrodeposited Coatings of Zinc on Iron and Steel
8. ASTM C 1048: Specification for Heat-Treated Flat Glass - Kind HS, Kind FT Coated and Uncoated Glass
9. ASTM C 1107: Specification for Packaged Dry, Hydraulic-Cement Grout (Nonshrink)
10. ASTM E 488: Test Methods for Strength of Anchors in Concrete and Masonry Elements
11. ASTM E 894: Test Method for Anchorage of Permanent Metal Railing Systems and Rails for Buildings
12. ASTM E 935: Test Methods for Performance of Permanent Metal Railing Systems and Rails for Buildings

13. ASTM F 1941: Specification for Electrodeposited Coatings on Threaded Fasteners (Unified Inch Screw Threads [UN/UNR])
 - D. Code of Federal Regulations
 1. 16 CFR 1201: Safety Standard for Architectural Glazing Materials
 - E. National Association of Architectural Metal Manufacturers
 1. Metal Finishes Manual for Architectural and Metal Products.
- 1.3 DEFINITIONS
- A. Railings: Guards, handrails, and similar devices used for protection of occupants at open-sided floor areas, pedestrian guidance and support, visual separation, or wall protection.
- 1.4 PERFORMANCE REQUIREMENTS
- A. Delegated Design: Design railings, including comprehensive engineering analysis by a qualified professional engineer, using performance requirements and design criteria indicated.
 - B. General: In engineering railings to withstand structural loads indicated, determine allowable design working stresses of railing materials based on the following:
 1. Stainless Steel: 60 percent of minimum yield strength.
 2. Glass: 25 percent of mean modulus of rupture (50 percent probability of breakage), as listed in "Mechanical Properties" in AAMA's Aluminum Curtain Wall Series No. 12, "Structural Properties of Glass."
 - C. Structural Performance: Railings shall withstand the effects of gravity loads and the following loads and stresses within limits and under conditions indicated:
 1. Handrails and Top Rails of Guards:
 - a. Uniform load of 50 lbf/ft. (0.73 kN/m) applied in any direction.
 - b. Concentrated load of 200 lbf (0.89 kN) applied in any direction.
 - c. Uniform and concentrated loads need not be assumed to act concurrently.
 2. Infill of Guards:
 - a. Concentrated load of 50 lbf (0.22 kN) applied horizontally on an area of 1 sq. ft. (0.093 sq. m).
 - b. Infill load and other loads need not be assumed to act concurrently.

1.5 SUBMITTALS

- A. Product Data: For the following:
 - 1. Manufacturer's product lines of railings assembled from standard components.
 - 2. Anchoring systems.
- B. Shop Drawings: Include plans, elevations, sections, details, and attachments to other work.
- C. Samples for Verification: For each type of exposed finish required.
 - 1. Sections of each distinctly different linear railing member, including handrails, top rails, posts, and balusters.
 - 2. Each type of glass or metal infill required.
 - 3. Fittings.
 - 4. Welded connections.
 - 5. Assembled Samples of railing systems, made from full-size components, including top rail, post, handrail, and infill. Show method of finishing members at intersections. Samples need not be full height.
- D. Delegated-Design Submittal: For installed products indicated to comply with performance requirements and design criteria, including analysis data signed and sealed by the qualified professional engineer responsible for their preparation.
- E. Field Test Reports.

1.6 QUALITY ASSURANCE

- A. Source Limitations: Obtain each type of railing from single source from single manufacturer.
 - 1. Modifications must be judged and approved by the Owner for this work.
- B. Product Options: Information on Drawings and in Specifications establishes requirements for system's aesthetic effects and performance characteristics. Aesthetic effects are indicated by dimensions, arrangements, alignment, and profiles of components and assemblies as they relate to sightlines, to one another, and to adjoining construction. Performance characteristics are indicated by criteria subject to verification by one or more methods including structural analysis, preconstruction testing, field testing, and in-service performance.
 - 1. Do not modify intended aesthetic effects, as judged solely by DFW with DFW Concessions approval. If modifications are proposed, submit comprehensive explanatory data to Architect for review.

- C. Welding Qualifications: Qualify procedures and personnel according to the following:
 - 1. AWS D1.6, "Structural Welding Code - Stainless Steel."
- D. Safety Glazing Labeling: Permanently mark glass with certification label of the SGCC or another certification agency acceptable to authorities having jurisdiction or manufacturer. Label shall indicate manufacturer's name, type of glass, thickness, and safety glazing standard with which glass complies.
- E. Preinstallation Meeting: Conduct meeting on project site with Terminal Construction Team, DFW Concessions TPM Team and Tenant Contractor.

1.7 PROJECT CONDITIONS

Field Measurements: Verify construction contiguous with railings by field measurements before fabrication and indicate measurements on Shop Drawings.

1.8 COORDINATION AND SCHEDULING

- A. Coordinate installation of anchorages for railings. Furnish setting drawings, templates, and directions for installing anchorages including anchor bolts and items with integral anchors that are to be embedded in concrete or masonry. Deliver such items to Project site in time for installation.

PART 2 - PRODUCTS

2.1 METALS, GENERAL

- A. Metal Surfaces, General: Provide materials with smooth surfaces, without seam marks, roller marks, rolled trade names, stains, discolorations, or blemishes.
- B. Brackets, Flanges, and Anchors: Same metal and finish as supported rails unless otherwise indicated.
 - 1. Provide cast-metal brackets with flange tapped for concealed anchorage to threaded hanger bolt.
 - 2. Provide either formed- or cast-metal brackets with predrilled hole for exposed bolt anchorage.

2.2 STAINLESS STEEL

- A. Tubing: ASTM A 554, Grade MT 304.
- B. Pipe: ASTM A 312/A 312M, Grade TP 304.
- C. Castings: ASTM A 743/A 743M, Grade CF 8 or CF 20.
- D. Sheet, Strip, Plate, and Flat Bar: ASTM A 666, Type 304.
- E. Bars and Shapes: ASTM A 276, Type 304.

- F. Perforated Metal: Stainless-steel sheet, ASTM A 240/A 240M or ASTM A 666, Type 304.
 - 1. Size and Spacing of Perforations: As selected by Tenant.
 - 2. Thickness for Metal-Infill Panels: As approved by DFW Concessions. Tenant must provide adequate thickness and design to ensure structural integrity.

2.3 GLASS MATERIALS

- A. Tempered Glass: ASTM C 1048, Kind FT (fully tempered), Condition A (uncoated), Type 1 (transparent flat glass), Quality-Q3. Provide products that have been tested for surface and edge compression according to ASTM C 1048 and for impact strength according to 16 CFR 1201 for Category II materials.
 - 1. Glass Color: As approved by DFW Concessions. Applied film, etched, sandblasted or decal must be approved by DFW Concessions.
 - 2. Thickness for Glass Infill Panels: As required by structural loads, but not less than 10.0 mm.

2.4 OTHER MATERIAL

- A. Infill Panels: As approved by DFW Concessions.

2.5 FASTENERS

- A. Fastener Materials: Unless otherwise indicated, provide the following:
 - 1. Stainless-Steel Components: Type 304 stainless-steel fasteners.
 - 2. Uncoated Steel Components: Plated-steel fasteners complying with ASTM B 633, Class Fe/Zn 25 for electrodeposited zinc coating where concealed; Type 304 stainless-steel fasteners where exposed.
 - 3. Dissimilar Metals: Type 304 stainless-steel fasteners.
- B. Fasteners for Anchoring to Other Construction: Select fasteners of type, grade, and class required to produce connections suitable for anchoring railings to other types of construction indicated and capable of withstanding design loads.
- C. Provide concealed fasteners for interconnecting railing components and for attaching railings to other work unless exposed fasteners are the standard fastening method for railings indicated.
 - 1. Provide tamper-resistant flat-head machine screws for exposed fasteners unless otherwise indicated.
- D. Anchors, General: Anchors capable of sustaining, without failure, a load equal to six times the load imposed when installed in unit masonry and four times the load imposed when installed in concrete, as determined by

testing according to ASTM E 488, conducted by a qualified independent testing agency.

- E. Post-Installed Anchors: Torque-controlled expansion anchors or chemical anchors.
 - 1. Material for Interior Locations: Carbon-steel components zinc plated to comply with ASTM B 633 or ASTM F 1941 (ASTM F 1941M), Class Fe/Zn 5, unless otherwise indicated.

2.6 MISCELLANEOUS MATERIALS

- A. Welding Rods and Bare Electrodes: Select according to AWS specifications for metal alloy welded.
- B. Nonshrink, Nonmetallic Grout: Factory-packaged, nonstaining, noncorrosive, nongaseous grout complying with ASTM C 1107. Provide grout specifically recommended by manufacturer for interior and exterior applications.
- C. Anchoring Cement: Factory-packaged, nonshrink, nonstaining, hydraulic-controlled expansion cement formulation for mixing with water at Project site to create pourable anchoring, patching, and grouting compound.

2.7 FABRICATION

- A. General: Fabricate railings to comply with requirements indicated for design, dimensions, member sizes and spacing, details, finish, and anchorage, but not less than that required to support structural loads.
- B. Assemble railings in the shop to greatest extent possible to minimize field splicing and assembly. Disassemble units only as necessary for shipping and handling limitations. Clearly mark units for reassembly and coordinated installation. Use connections that maintain structural value of joined pieces.
- C. Cut, drill, and punch metals cleanly and accurately. Remove burrs and ease edges to a radius of approximately 1/32 inch (1 mm) unless otherwise indicated. Remove sharp or rough areas on exposed surfaces.
- D. Form work true to line and level with accurate angles and surfaces.
- E. Fabricate connections that will be exposed to weather in a manner to exclude water. Provide weep holes where water may accumulate. Locate weep holes in inconspicuous locations.
- F. Cut, reinforce, drill, and tap as indicated to receive finish hardware, screws, and similar items.
- G. Connections: Fabricate railings with welded connections unless otherwise indicated.
- H. Welded Connections: Cope components at connections to provide close fit, or use fittings designed for this purpose. Weld all around at connections, including at fittings.

1. Use materials and methods that minimize distortion and develop strength and corrosion resistance of base metals.
 2. Obtain fusion without undercut or overlap.
 3. Remove flux immediately.
 4. At exposed connections, finish exposed welds to comply with NOMMA's "Voluntary Joint Finish Standards" for Type 1 welds: no evidence of a welded joint.
- I. Form changes in direction as follows:
 1. By flush bends or by inserting prefabricated flush-elbow fittings.
 - J. Close exposed ends of hollow railing members with prefabricated end fittings.
 - K. Flanges, Fittings, and Anchors: Provide flanges, miscellaneous fittings, and anchors to interconnect railing members to other work unless otherwise indicated.
 - L. Provide inserts and other anchorage devices for connecting railings to concrete or masonry work. Fabricate anchorage devices capable of withstanding loads imposed by railings. Coordinate anchorage devices with supporting structure.

2.8 GLAZING PANEL FABRICATION

- A. General: Fabricate to sizes and shapes required; provide for proper edge clearance and bite on glazing panels.
 1. Grind smooth exposed edges, including those at open joints, to produce square edges with slight chamfers at junctions of edges and faces.

2.9 REQUIREMENTS

- A. Comply with NAAMM's "Metal Finishes Manual for Architectural and Metal Products" for recommendations for applying and designating finishes.
- B. Protect mechanical finishes on exposed surfaces from damage by applying a strippable, temporary protective covering before shipment.
- C. Appearance of Finished Work: Noticeable variations in same piece are not acceptable. Variations in appearance of abutting or adjacent pieces are acceptable if they are within one-half of the range of approved Samples. Variations in appearance of other components are acceptable if they are within the range of approved Samples and are assembled or installed to minimize contrast.
- D. Provide exposed fasteners with finish matching appearance, including color and texture, of railings.

2.10 STAINLESS-STEEL FINISHES

- A. Surface Preparation: Remove tool and die marks and stretch lines, or blend into finish.
- B. Welding: Grind and polish surfaces to produce uniform finish, free of cross scratches.
 - 1. Run grain of directional finishes with long dimension of each piece.
- C. Brushed stainless steel, reflective, directional polish: No. 7.
- D. When finishing is completed, passivate and rinse surfaces. Remove embedded foreign matter and leave surfaces chemically clean.

PART 3 - EXECUTION

3.1 INSTALLATION, GENERAL

- A. Fit exposed connections together to form tight, hairline joints.
- B. Perform cutting, drilling, and fitting required for installing railings. Set railings accurately in location, alignment, and elevation; measured from established lines and levels and free of rack.
 - 1. Do not weld, cut, or abrade surfaces of railing components that have been coated or finished after fabrication and that are intended for field connection by mechanical or other means without further cutting or fitting.
 - 2. Set posts plumb within a tolerance of 1/16 inch in 3 feet (2 mm in 1 m).
 - 3. Align rails so variations from level for horizontal members and variations from parallel with rake of steps and ramps for sloping members do not exceed 1/4 inch in 12 feet (5 mm in 3 m).
- C. Adjust railings before anchoring to ensure matching alignment at abutting joints.
- D. Fastening to In-Place Construction: Use anchorage devices and fasteners where necessary for securing railings and for properly transferring loads to in-place construction.

RAILING CONNECTIONS

- E. Nonwelded Connections: Use mechanical or adhesive joints for permanently connecting railing components. Use wood blocks and padding to prevent damage to railing members and fittings. Seal recessed holes of exposed locking screws using plastic cement filler colored to match finish of railings.

3.2 INSTALLING INFILL PANELS

- A. Install assembly to comply with railing manufacturer's written instructions.
 - 1. Adjust spacing panels so gaps between panels are equal before securing in position.

2. Erect railings and infill panels under direct supervision of manufacturer's authorized technical personnel.
- B. Installation Tolerances:
1. Maximum variation from level or from indicated slopes: 1/4 inch in 10 feet, noncumulative.
 2. Maximum offset from true alignment of abutting members: 1/16 inch.

3.3 FIELD QUALITY CONTROL

- A. Testing Agency: Owner will engage a qualified testing and inspecting agency to perform field tests and inspections and prepare test reports. Payment for these services will be made by Owner.
- B. Extent and Testing Methodology: Testing agency will randomly select completed railing assemblies for testing that are representative of different railing designs and conditions in the completed Work. Railings will be tested according to ASTM E 894 and ASTM E 935 for compliance with performance requirements.
- C. Remove and replace railings where test results indicate that they do not comply with specified requirements unless they can be repaired in a manner satisfactory to Architect and will comply with specified requirements.
- D. Additional testing and inspecting, at Contractor's expense, will be performed to determine compliance of replaced or additional work with specified requirements.

3.4 CLEANING

- A. Clean stainless steel by washing thoroughly with clean water and soap, rinsing with clean water, and wiping dry.
- B. Clean and polish glass as recommended in writing by manufacturer. Wash both exposed surfaces in each area of Project not more than four days before date scheduled for inspections that establish date of Substantial Completion.
- C. Other Materials: As recommended in writing by Manufacturer

3.5 PROTECTION

- A. Protect finishes of railings from damage during construction period with temporary protective coverings approved by railing manufacturer. Remove protective coverings at time of Substantial Completion.
- B. Restore finishes damaged during installation and construction period so no evidence remains of correction work. Return items that cannot be refinished in the field to the shop; make required alterations and refinish entire unit, or provide new units.

- END OF SECTION -